



EXPEC 3500 series GC-MS



SUPEC 7000 series ICP-MS



EXPEC 5210 series LC-MS/MS



Fully automatic heavy metal analysis system



EXPEC 6500 series ICP-OES



EXPEC 1370/1330 series NIR



SUPEC 5000 Series Permanganate Index



# EXPEC 5210 LC-MS/MS

A new generation of main tandem mass spectrometry

Hangzhou EXPEC Technology Development Co., Ltd.  
No. 2466 Keji Avenue, Qingshanhu Street, Lin'an District, Hangzhou City, Zhejiang Province  
Post Code: 310052  
Telephone: 0571-85012185  
Fax: 0571-85012001  
Website: [en.expec-tech.com/](http://en.expec-tech.com/)  
Mailbox: [sales\\_expec@fpi-inc.com](mailto:sales_expec@fpi-inc.com)  
Hotline: 400 700 2658



### Product Overview

EXPEC 5210 is a triple quadrupole tandem mass spectrometer with independent intellectual property rights developed by Hangzhou PuYu Technology Development Co., Ltd., with the support of "national major scientific instrument and equipment development project", after years of research and development investment and employing a series of innovative mass spectrometry technologies. Aiming at the core technology of three quadrupole tandem mass spectrometry, the key technologies of high stability electrospray ion source, high efficiency solvent removal ion interface, triple quadrupole with high ion transmission efficiency, triple quadrupole mass analyzer, high-speed collision cell, and RF circuit drive have been resolved, and a new triple quadrupole tandem mass spectrometry product with superior performance has been built.

EXPEC 5210 has excellent sensitivity and stability, outstanding scalability and best cost performance and is suitable for a wide range of application fields such as environmental testing, medical testing and food safety. The mass spectrometry workstation software in all Chinese independently developed for user needs, "Mass Expert", includes professional mass spectrometry control and quantitative analysis software, combined with standard method library, automatic tuning, intelligent batch processing and customized report output functions, which greatly reduces the operation difficulty of mass spectrometry software system. At the same time, Mass Expert also has thousands of compound standard libraries and rich application method libraries to meet the application needs of more mass spectrometry users.



### EXPEC 5210 triple quadrupole mass spectrometry

Excellent performance and easy operation make it possible for LC-MS to enter more testing laboratories.

#### Unique design of biorthogonal ion source and double 3Q ion optical

- EXPEC 5210 has excellent ionic yield and resistance to matrix with adopting ESpray biorthogonal electrospray ion source technology. EXPEC 5210 adopts unique triple quadrupole ion guidance technology and triple quadrupole mass analyzer technology to ensure the analytical performance and long-term stability.

#### Excellent sensitivity

- The product adopts the Step Scan, a kind of newly designed ion transmission technology, which effectively improves the ion transmission efficiency.
- The innovative technology of axial acceleration collision cell improves the collision efficiency greatly.
- The patented technology of pulse counting detection can detect ion signals without loss and filter noise interference effectively.

#### Excellent stability

- Ion source and ion interface with efficient desolvation to increase system tolerance.
- The patented closed-loop adaptive adjustment technology of dual RF power supply improves the stability of quadrupole RF power supply.
- The patented anti temperature and humidity alternating technology is suitable for a wider range of temperature and humidity applications.

#### Mass Expert mass spectrometry workstation in Chinese

- The control software and analysis software of completely new Mass Expert mass spectrometry in Chinese are simple to operate. The function of one-click automatic tuning and quality calibration reduces the complexity of instrument control and the threshold of instrument use. Mass spectrometry analysis software and report template can be customized according to different application fields and different users to meet the use needs of various application fields.

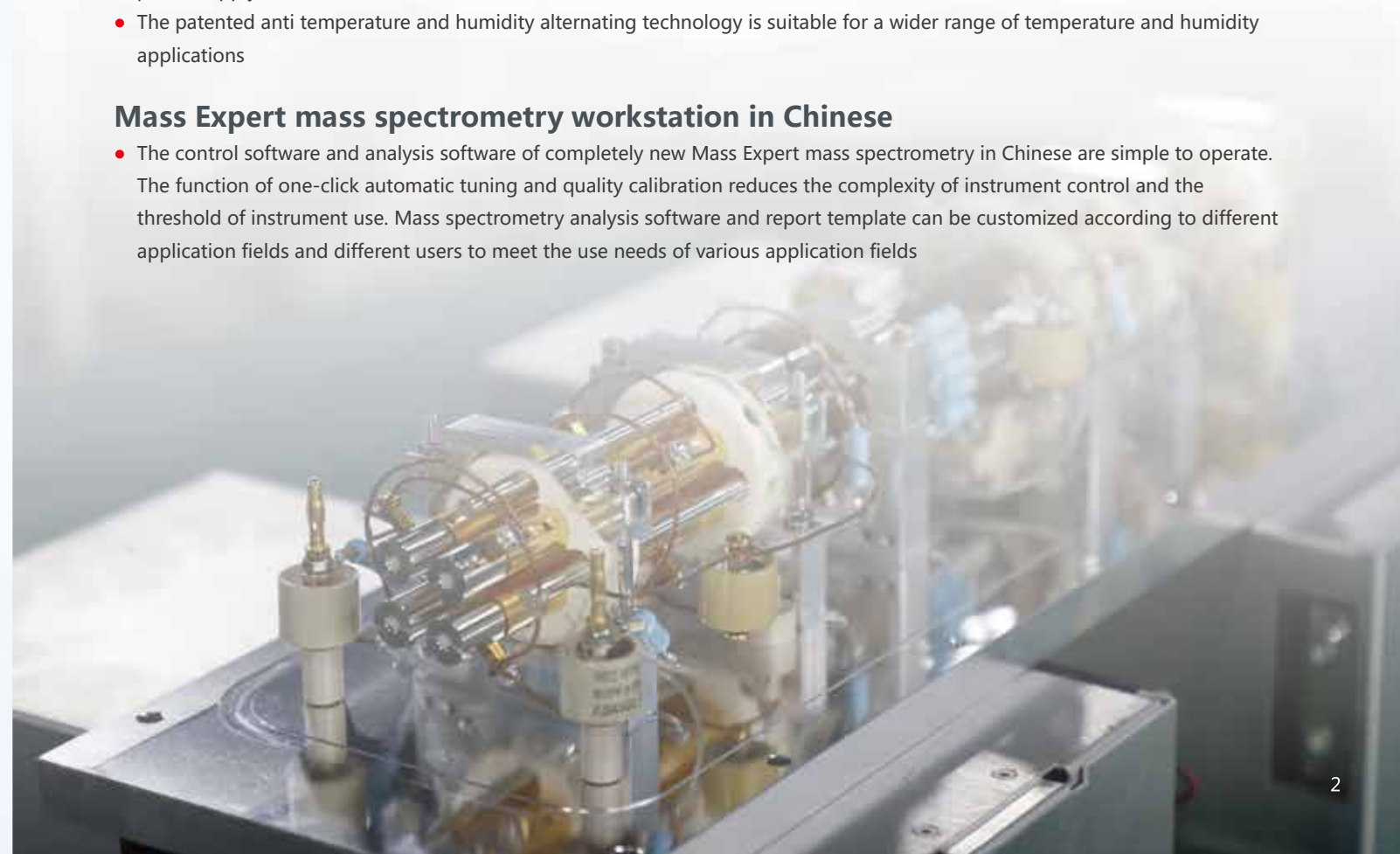



# Innovative triple quadrupole mass spectrometry

## Ion interface

- Gas circuit with special heating, independent temperature control for blowback gas
- Blowback gas designed to further improve the desolvation
- High purity nitrogen back blowing to eliminate interference

## Biorthogonal e-spray ion source

- Powerful and scalable ESI ion source.
- Orthogonal ion path with 90 degree deflection to reduce neutral particles entering the mass spectrum and reduce noise.
- Orthogonal symmetrical two-way desolvation gas based on flow field simulation to maximize solvent removal

## Reliable multistage vacuum system

- Multi stage vacuum system based on molecular pump and front stage pump
- Step transition of vacuum to reduce sudden change of air pressure and ion loss

## Perfect instrument control system

- All gas circuits, voltages and heating have interlocking control to ensure equipment safety.
- The vacuum system is independently controlled and has perfect self-protection. It can ensure the normal operation of the system without software.
- All gas circuits are controlled by MFC to control all parameters accurately.



## Step Scan ion transport

- 3Q quadrupole transmission system design is adopted to maximize transmission efficiency.
- Axially accelerated Q-funnel ion acquisition to improve ion transmission efficiency
- Unique Q-lens, connected with ion interface perfectly
- Q-guide, improved quadrupole transmission channel to ensure all ions efficient transmission.

## TQ quality analyzer

- Pure molybdenum quadrupole mass analyzer with gold plating for best thermal stability.
- Ultra stable frequency modulation quadrupole RF power supply, with excellent resistance to temperature and humidity changes, ensuring good stability under ordinary laboratory conditions.

## TQ quality analyzer

- The patented second generation Hexapole Collision reaction tank
- The design of axial acceleration enables ions to pass through the collision cell quickly, taking into account collision efficiency and transmission efficiency
- The patented distributed collision gas diffusion mode improves collision efficiency and sensitivity greatly.

## Pulse counting detector

- Proprietary channel electronic multiplier with deflection
- The patented pulse count detection with higher signal response and lower noise

# Robust and efficient ion optics

The innovative double 3Q ion optical system has high ion transmission efficiency, good matrix tolerance, good balance sensitivity and stability, and has excellent application performance.

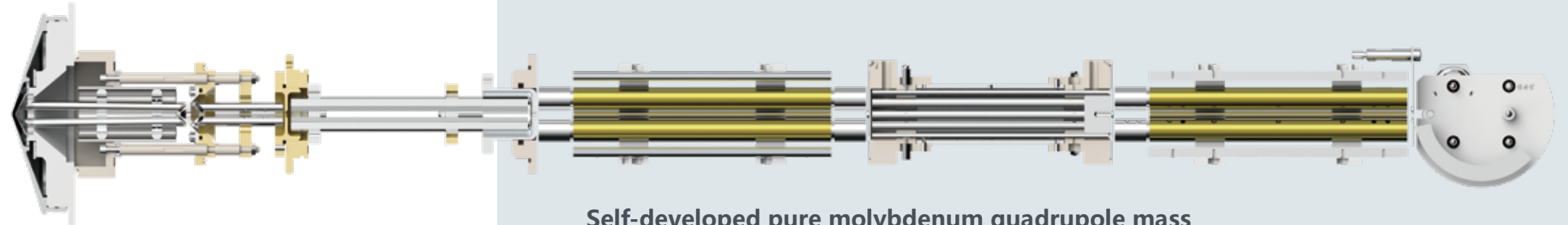

## Step Scan 3Q ion transport system

- Integrated packaging, easy to disassemble and cleaning
- Three groups of quadrupoles form a unique 3Q ion transmission channel with large ion path and high ion transmission efficiency
- Quadrupole design and step scanning can reduce the interference of low quality ions greatly

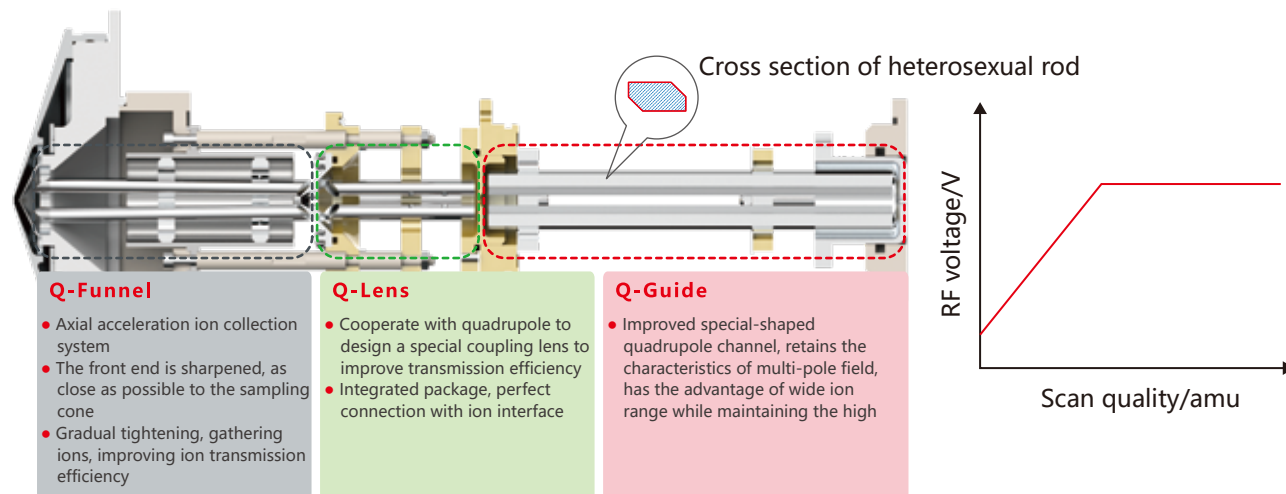

## Tandem QQQ quality analyzer

- Adopt design of tandem Quadrupole mass analyzer and Six-pole collision cell.
- The stable dual mass analyzer can carry out various mass analysis scans and is suitable for various mass spectrometry research work.
- Efficient collision cell for maximum ion transport.
- Including full scan, SIM, SRM, product ion scan, precursor ion scan, neutral loss scan and MRM.

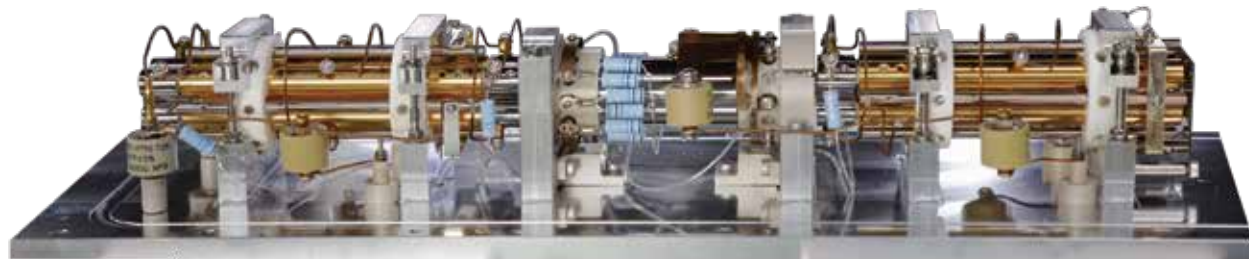

## Self-developed pure molybdenum quadrupole mass analyzer

- Pure molybdenum quadrupole with the best material stability to ensure the stability of the quality axis
- The surface of quadrupole is plated with gold and completely inert to eliminate organic deposition
- The patented closed-loop adaptive adjustment technology of dual RF power supply to improve the stability of quadrupole RF
- The patented temperature and humidity alternating resistance technology can adapt to the working environment of (15 ~ 30) °C, (20 ~ 80)% R.H

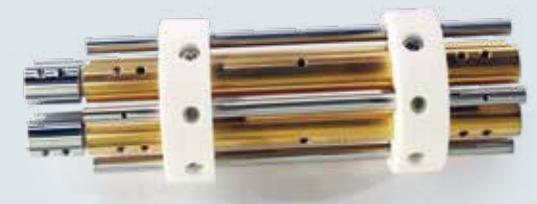

## Axial acceleration collision cell

- Eliminate crosstalk between ion pairs and no memory effect.
- Matching ultra-fast liquid chromatography for high-throughput analysis of nearly 100 compounds at the same time

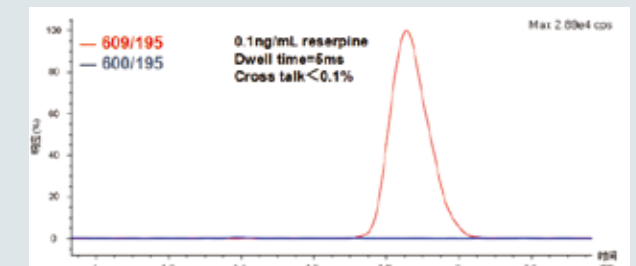
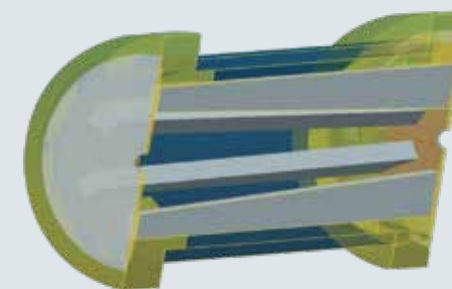

Collision cell cross-contamination experiment results; the experiment uses two channels: the true channel 609-195 and the false channel 600-195, the dwell time is 5ms, and the ratio of the peak area of the false channel to that of the true channel is less than 0.1%.

## Advanced quadrupole RF power supply technology

- The patented closed-loop adaptive adjustment technology of dual RF power supply is adopted to improve the stability of quadrupole RF voltage, ensure the symmetry of RF power supply, and improve the accuracy of ion screening and ion transmission greatly.
- Completely new temperature and humidity resistance technology is adopted to improve the environmental adaptability of quadrupole driving power supply, and the mass spectrum peaks are very stable in the full temperature and humidity range

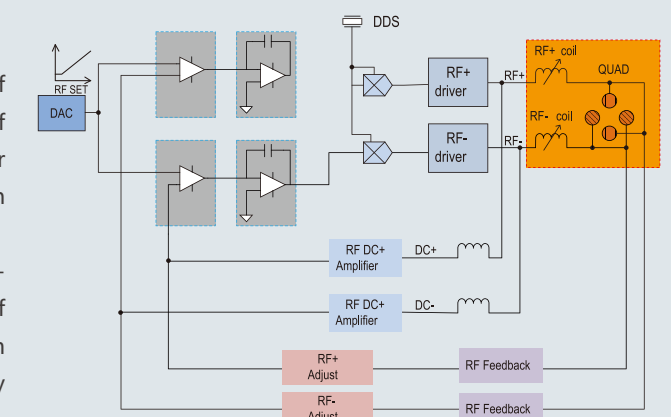



# Excellent stability serves the applications of LC-MS/MS

## Orthogonal transmission of E-Spray electro-spray ion source

- By orthogonal vertical spray ESI ion source with 90 degree deflation reduces direct injection neutral particle pollution, reducing noise while prolonging maintenance cycle greatly.
- Coaxial atomized forms a powerful and stable ion source, which is suitable for stable injection at various flow rates of 5ul / min ~ 2ml / min.
- the ion source is three-dimensional adjustable, which is suitable for users to optimize the ion collection position according to the actual situation.



## Ultra trace signal detection

- Channel electronic multiplier
- The design of off axis to filter the noise of neutral particle
- Innovative pulse detection technology can improve the signal-to-noise ratio effectively and obtain better analysis results.

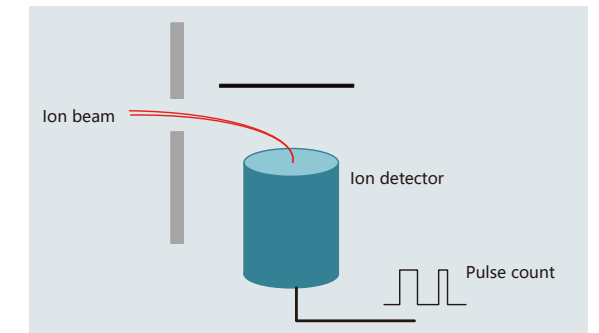

## Orthogonal desolvation gas, aerodynamic and efficient desolvation

- Based on the distribution of aerodynamics and thermodynamics, the spatial position of desolvation gas is optimized, and the orthogonal and symmetrical arrangement has the best desolvation effect.
- Independent temperature control of two-way desolvation gas, and the maximum desolvation gas temperature can reach 700 °C.
- The temperature and flow of desolvation gas can be automatically optimized and switched, and can be flexibly adjusted according to the application to achieve the best effect of desolvation

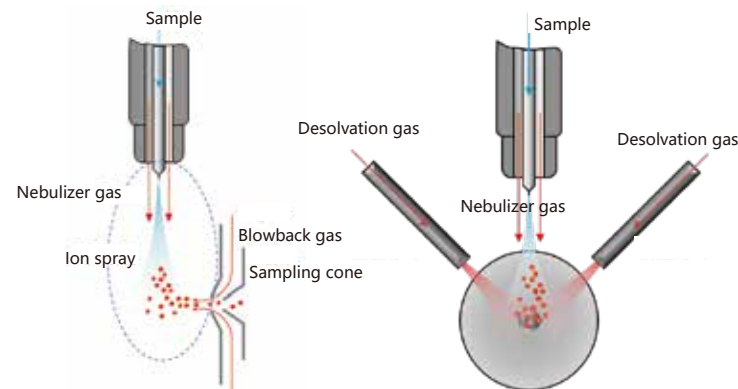

## Vacuum system

- Differential vacuum design to reduce ion transmission loss
- At the same time, it also reduces the molecular pump load and improves the service life of the turbo molecular pump

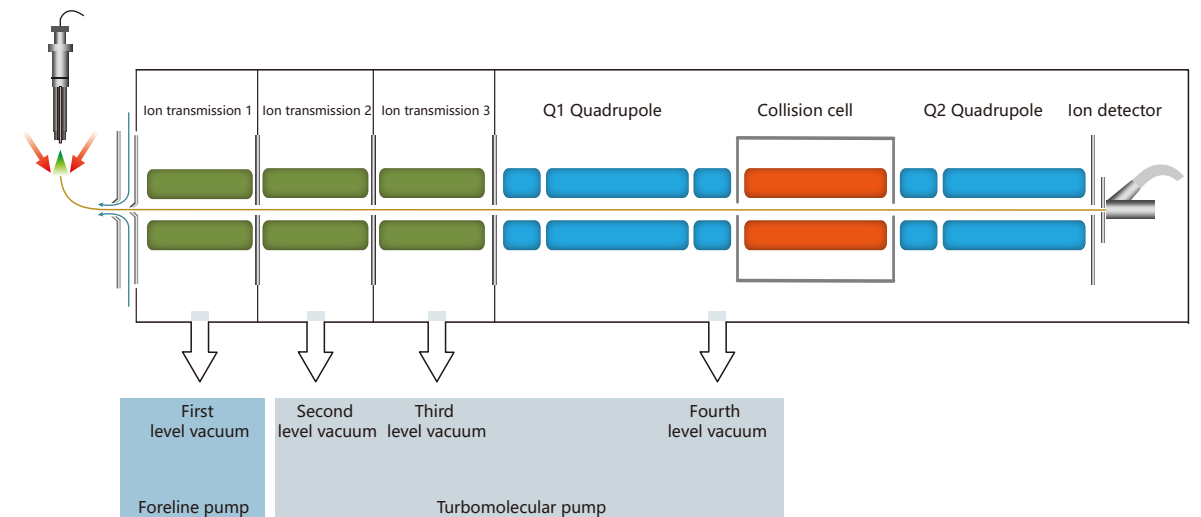

## Anti-pollution vacuum interface

- Gas curtain formed by back blowing of high temperature nitrogen flow
- Effective removal of neutral particles
- Prevent large droplets from entering the vacuum area
- Micro negative pressure in atomization chamber to discharge solvent droplets



## Excellent stability

- 1000 needles of continuous injection over 168 hours, peak area of 3 sulfonamides CV < 4%

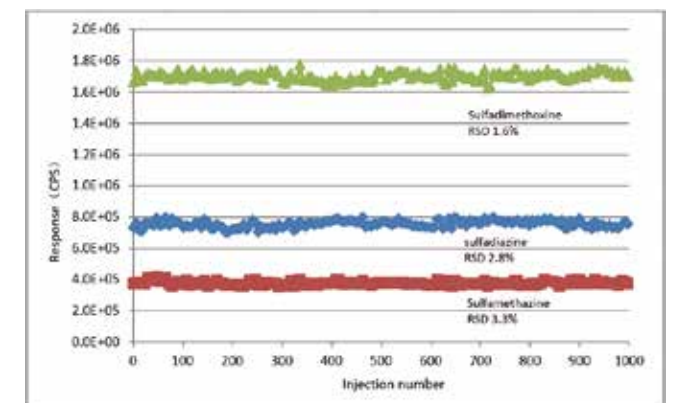

# Powerful and friendly Mass Expert analysis workstation

## Powerful and friendly Mass Expert analysis workstation

- Mass Expert workstation in all Chinese, a kind of new user experience, and there are no learning disabilities.
- With rich intelligent kits to meet the application needs of different levels from experts to experimenters
- Powerful high-throughput data batch analysis software makes analysts no longer stay at the side of the instrument
- The built-in standard spectrum library contains thousands of compounds, and supports self-built spectrum library, which is convenient for users to build their own methods.
- Provide special solutions for industrial applications, and provide customized method packages for environmental monitoring, online analysis, etc.

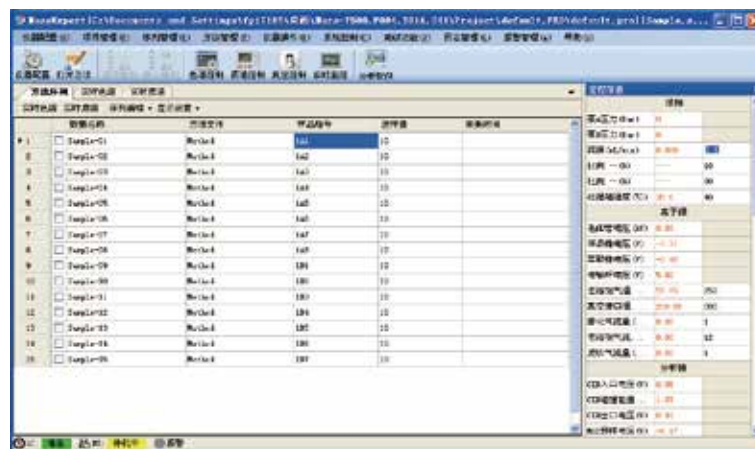

## Easy to use Easy-to-use control software

- The interface in full Chinese, with new user experience
- Optimize the methods automatically to accelerate the development process of method.
- Monitor the instrument status in real time to reduce the difficulty of diagnosis and maintenance

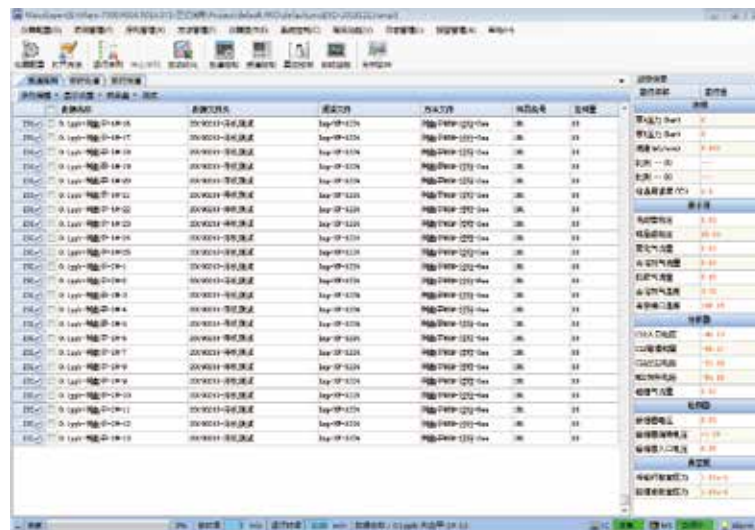

## Intelligent parameter optimization

- One-click automatic tuning and quality calibration to reduce the difficulty of users
- Parameter adjustment tool tailored for advanced users to meet personalized experimental needs

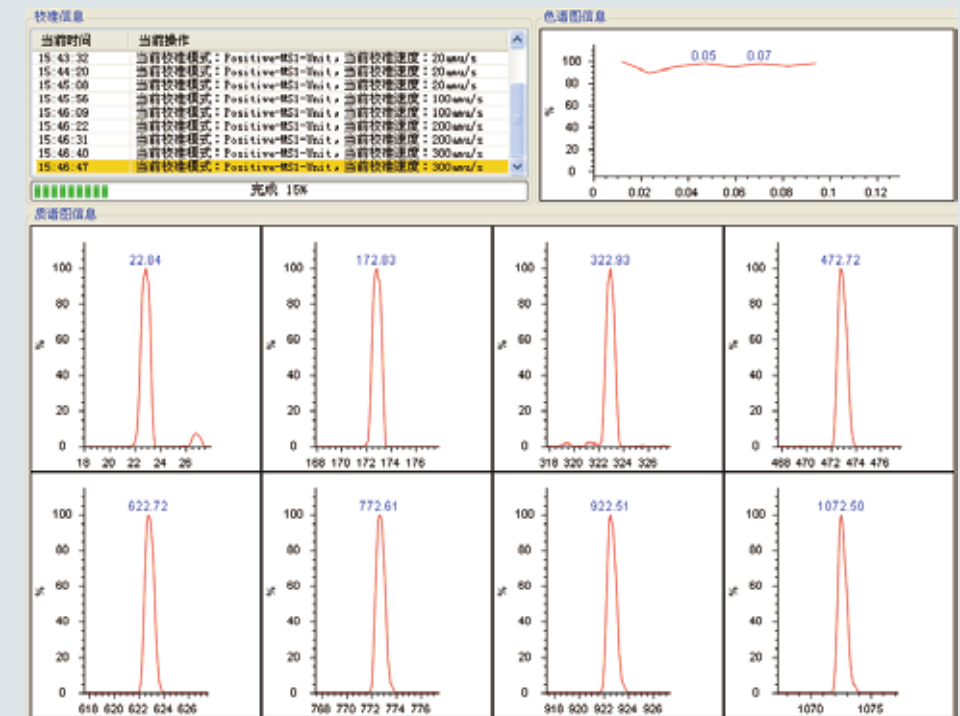

## Customizable application analysis software

- Customized special software for environmental protection, medical diagnosis, food safety, online analysis and other applications.
- In-built compound library and analytical method library to provide analytical method support for compounds
- Mark outliers automatically to speed up analysis
- The setting of no parameter automatic integrator to reduce the tedious operation of manual integration
- Analysis data statistics and trend displayed by chart are convenient and intuitive

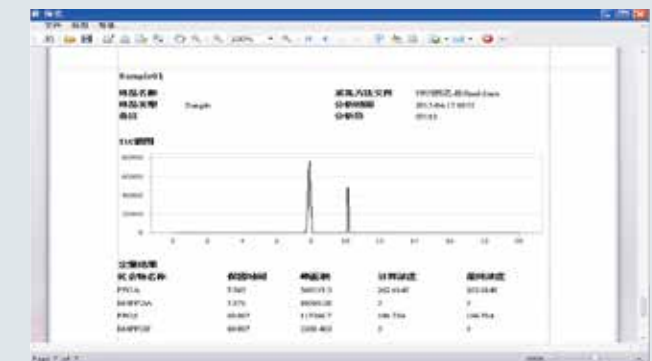





## Humanized design to improve user experience

- Plunger rod self-cleaning (back wash) is equipped as standard to reduce the impact of buffer salt on the pump system and prolong the service life of the gasket
- Online degasser (Degasser) is equipped as standard to reduce user's exhaust bubble operation and improve system operation stability.
- Solvent switching valve (SSV, optional), which can quickly switch four mobile phases on the binary pump without manual switching of mobile phases

## The system has small delay and realizes rapid gradient change

- The gradient of mobile phase B (5% → 95%) changed rapidly within 2 min, and then balanced to the initial 5% B within 25s, reflecting the super performance of the infusion pump

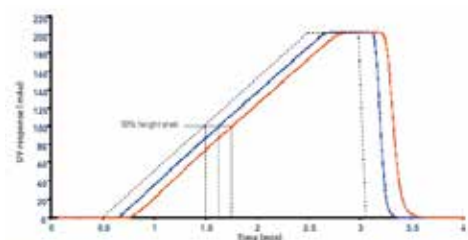

Figure 2: Linear gradient utilizing identical solvents (A & B), Red 0.25 mL/min, Blue 0.5 mL/min.

High gradient accuracy to ensure experiment repeatability

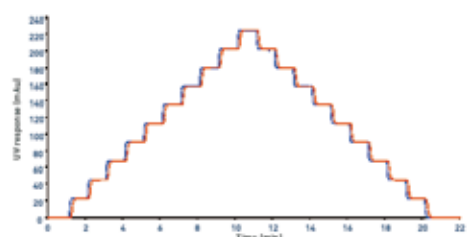

Figure 3: Step gradient utilizing identical solvents (A & B), Red 0.25 mL/min, Blue 0.5 mL/min.

Flow (mL/min)	Solvent composition accuracy (Bias, %)									
	10	20	30	40	50	60	70	80	90	
0.25	0.02	0.05	0.04	0.07	0.15	0.20	0.19	0.07	0.05	±0.05
	0.04	0.11	0.14	0.14	0.14	0.14	0.14	0.22	-0.01	
0.50	-0.02	-0.04	-0.03	-0.04	-0.02	-0.01	-0.03	0.08	0.23	±0.05
	0.00	0.04	0.04	0.04	0.05	0.03	-0.01	-0.01	-0.02	

## Multifunctional injector to realize ultra-low temperature injection

- Matching multiple types of injection trays
  - ▾ 48 position sample tray (2ml universal sample bottle)
  - ▾ 96 position shallow hole plate / deep hole plate
  - ▾ 384 bit microplate
  - ▾ 10ml sample bottle
- Ultra low temperature sample injection function (optional):
  - ▾ truly realize the cooling injection at 4 ° C, which is suitable for easily deteriorated samples such as biological samples



## Unique needle washing design realizes zero residue of samples

- The "needle inside needle" design of the combination of outer needle and inner needle truly realizes zero residues of samples
- Programmable needle washing program, which can switch up to 6 kinds of needle washing solutions



## Reliable column oven

- Temperature range: room temperature + 5 ° C - 90 ° C, accuracy < 0.1 ° C
- Multi-dimensional alarm protection to ensure the normal operation of the system
  - ▾ liquid leakage alarm
  - ▾ Door opening alarm when heating
  - ▾ Heating timeout protection
  - ▾ Heating over temperature protection
- up to 6 different chromatographic columns can be switched through column switching valve to save time of method development.

## SUPEC 5210



EXPEC 5210 is a new generation of LC-MS / MS, with excellent sensitivity and stability. It is suitable for a wide range of application fields such as environmental testing, medical testing, drug testing and food safety.

EXPEC 5210 is equipped with Mass Expert mass spectrometry workstation in Chinese, including professional mass spectrometry control and quantitative analysis software. It contains thousands of compound standard libraries and rich application method libraries, which greatly reduces the operation difficulty of mass spectrometry software system.

### EXPEC 5210 LC-MS / MS analysis system can be configured:

- ULC 500 HPLC or ULC 510 UPLC
- AS 510 auto sampler
- CH 520 column temperature box

## SUPEC 5210 water quality online monitoring system



SUPEC 5210 is an on-line monitoring system based on the main LC-MS / MS for the water quality characteristic organic pollution factors. It can effectively realize the real-time on-line monitoring of water quality characteristic organic pollution compounds of surface water, drinking water and pollution sources. It is a sharp tool for the on-line monitoring of pesticide and veterinary drug residues, antibiotics and contraband in water.

The system adopts complete analysis processes including automatic sampling, ultrasonic filtration, on-line pretreatment (solid phase extraction), on-line mass spectrometry control and automatic LC - MS / MS analysis, which improves the performance greatly of on-line monitoring of organic pollutants in water; The detection limit as low as PPT level is realized, and the monitoring demand of organic matter index in water is truly realized.

# Application case



## 1. Detection of sulfonamides in pork

The limit of quantitation is 2 orders of magnitude better than the detection limit of national standard GB / T 20759 - 2006, and meets the detection and application needs of 16 sulfonamides in meat.

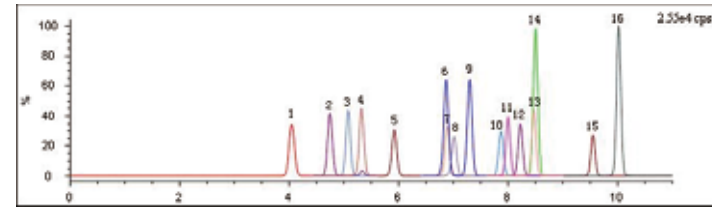

## 2. Detection of carbamate pesticides in water

It has a strong ability to analyze multicomponent pesticide residues in complex substrate of environmental water.

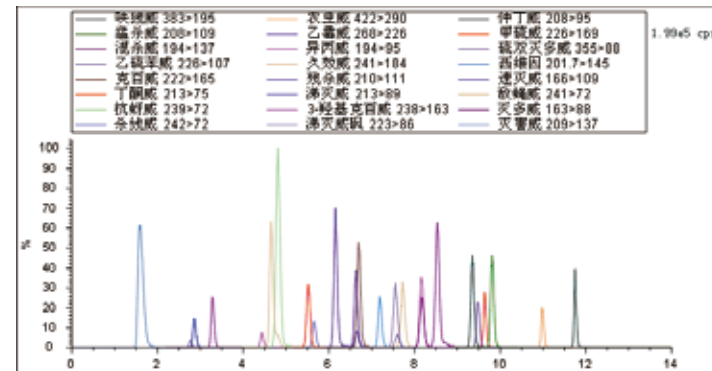

## 3. Detection of perfluorinated compounds in environmental media

EXPEC 5210 LC-MS / MS was used to quantitatively evaluate the pollution level of per fluorinated compounds in environmental media in ordinary areas (city A) and production areas (city B), so as to provide reference for environmental monitoring and treatment.

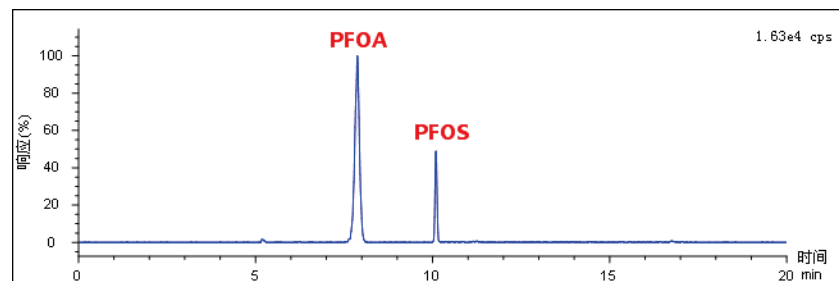

	A市		B市	
环境介质	PFOA	PFOS	PFOA	PFOS
地下水	轻度污染	轻度污染	重度污染	重度污染
地表水	轻度污染	轻度污染	重度污染	重度污染
鱼	N.D.	N.D.	中度污染	中度污染
土壤及其沉积物	N.D.	N.D.	N.D.	N.D.
大气	N.D.	N.D.	可能有污染	可能有污染

## 4. Screening of neonatal genetic metabolic diseases

More than 60 kinds of amino acids and acyl carnitine in neonatal blood were quantitatively analyzed by EXPEC 5210. More than 30 kinds of genetic and metabolic diseases could be screened in only 2 minutes each time.

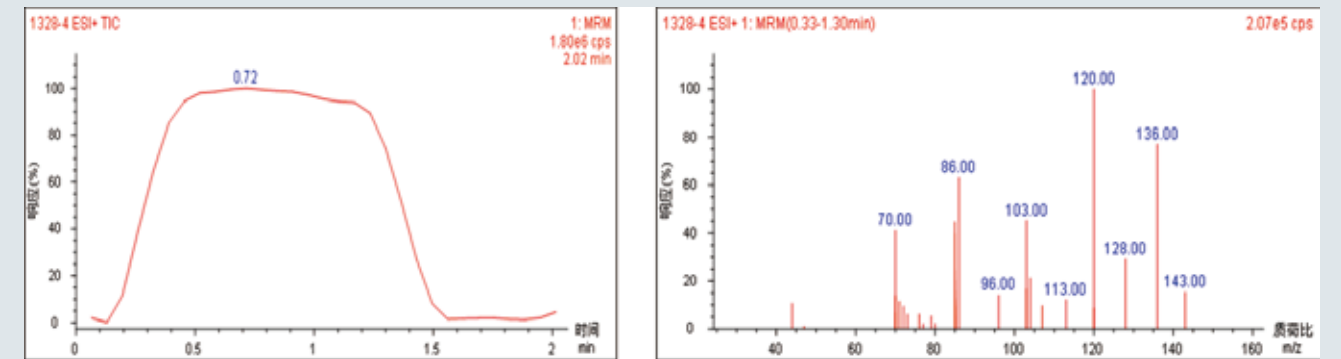

## 5. Determination of vitamin D in serum

The concentration of 25-hydroxy-vitamin D in serum was determined by EXPEC 5210 to evaluate the nutritional status of human vitamin D, which can meet the needs of clinical detection.

