

SemiPOL High Precision Quantitative Grinding Machine

GRINDING/POLISHING



2023

08 / 01

TROJAN (SUZHOU) MATERIAL TECHNOLOGY CO.,LTD

SemiPOL High Precision Quantitative Grinding Machine

SemiPOL can accurately grind and polish various materials (optical lenses, semiconductor wafers, metal and non-metal crystal phases) for microscopic (SEM, FIB, TEM, etc.) analysis. The target accuracy is micron level. It is mainly used for parallel grinding and polishing, combined with more accessories, would make the grinding and polishing of complex special-shaped parts and surfaces easier.

Monitor material removal in real time, or quantitatively set the amount of material to be ground and realize unattended operation. Dual stepping motor drive, respectively control the swing speed and amplitude of the grinding seat, can improve the flatness of the grinding parts, finish and utilization of grinding consumables.

Features:

- ◆ 7-inch touchscreen panel with a simple and easy-to-understand interface;
- ◆ Size of grinding disk: 10 inches (Φ254mm);
- ◆ Grinding disc speed: 0 – 350rpm, forward/reverse rotation;
- ◆ The LCD screen displays the amount of material removed in real time, with a resolution of 0.2um and a stable accuracy of ±2um;
- ◆ Built-in 16 groups of commonly used grinding and polishing process parameters, you can also save customized parameters;
- ◆ Large-diameter side-discharge water outlet is not easy to block and drains quickly;
- ◆ Pluggable faucet design facilitates cleaning and maintenance in the dish;
- ◆ Built-in automatic temperature-sensing cooling fan to reduce failure rate and extend working life.

Technical Specifications:

Model	SemiPOL	
Grinding head	Speed	0-50rpm. Infinitely adjustable speed
	Rotating direction	CW/CCW
	Semi-rotation	Yes, adjustable amplitude
	Swing	Yes, adjustable speed
	Torque of motor	0.8N/M
	Maximum removal	10mm
Grinder & polisher	Power	750W
	Speed	0-350rpm
	Diameter of grinding disc	8"-12"(203/254mm)
	Rotating direction	8"-12"(203/254mm)
Dripping (optional)	Pump flow	CW/CCW
	Number of pumps	4
Operating environment	Temperature	-20°C - 60°C
	Humidity	0-95%RH
Dimension	WxDxH	700x430x580mm
Weight		57kg

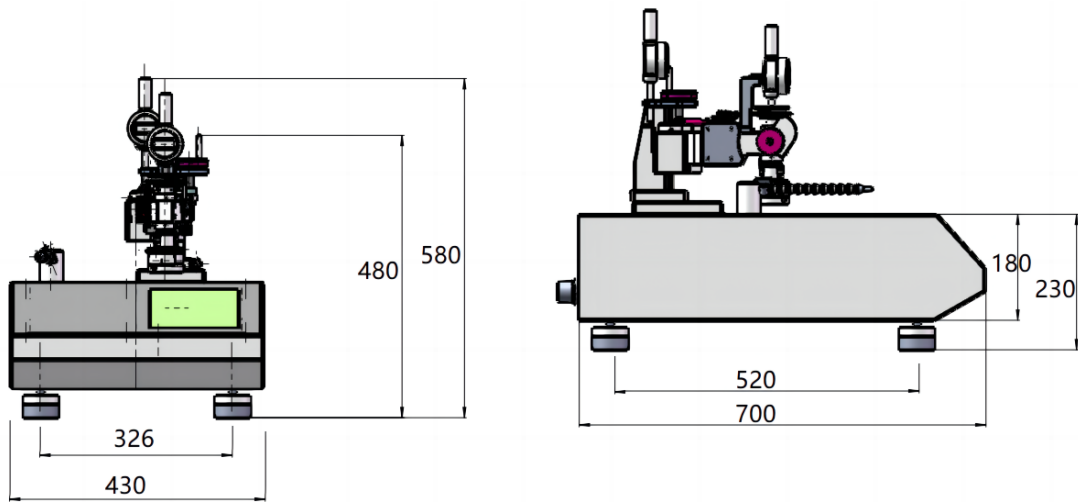

Control Panel Introduction:



Manual mode operation interface :







- ① Removal amount set value
- ② Current removal amount
- ③ Start/ stop
- ④ Cooling water
- ⑤ Save
- ⑥ Set starting point
- ⑦ Set time/removal amount
- ⑧ Set operating parameters



Automatic mode operation interface :

- ① Removal amount set value
- ② Current removal amount
- ③ Import program
- ④ Preview program
- ⑤ Run/stop
- ⑥ Cooling water
- ⑦ Back to homepage
- ⑧ Set operating parameters

Standard accessories:

1	Parallel Grinding Fixture		Diameter Φ 56mm	1
2	Differential table for verification		resolution 0.001mm	1
3	Digital dial indicator		25.4, 0.001mm	1
4	Power cable		0.75 square, 1.5m	1
5	Water inlet pipe and outlet pipe			1
6	Abrasive paper			Appropriate amount

Related Consumables & Accessories:



Abrasive Paper



Polishing Cloth



Alumina/Silica suspension

Purchase list:

Silicon Carbide Disc:

03.04.203	Silicon Carbide Disc(PSA)	200mm,120#	03.03.103	Silicon Carbide Disc(Plain Back)	50pcs
03.04.204	Silicon Carbide Disc(PSA)	200mm,180#	03.03.104	Silicon Carbide Disc(Plain Back)	100pcs
03.04.207	Silicon Carbide Disc(PSA)	200mm,400#	03.03.107	Silicon Carbide Disc(Plain Back)	100pcs
03.04.209	Silicon Carbide Disc(PSA)	200mm,800#	03.03.109	Silicon Carbide Disc(Plain Back)	100pcs
03.04.211	Silicon Carbide Disc(PSA)	200mm,1200#	03.03.111	Silicon Carbide Disc(Plain Back)	100pcs
03.04.213	Silicon Carbide Disc(PSA)	200mm,2000#	03.03.113	Silicon Carbide Disc(Plain Back)	100pcs
03.04.214	Silicon Carbide Disc(PSA)	200mm,2500#	03.03.114	Silicon Carbide Disc(Plain Back)	100pcs
03.04.215	Silicon Carbide Disc(PSA)	200mm,2400#	03.03.115	Silicon Carbide Disc(Plain Back)	100pcs
03.04.216	Silicon Carbide Disc(PSA)	200mm,4000#	03.03.116	Silicon Carbide Disc(Plain Back)	100pcs

Alumina Disc:

03.02.403	Alumina Disc (PSA)	200mm,120#	03.01.103	Alumina Disc (Plain Back)	50pcs
03.02.404	Alumina Disc (PSA)	200mm,180#	03.01.104	Alumina Disc (Plain Back)	100pcs
03.02.405	Alumina Disc (PSA)	200mm,320#	03.01.105	Alumina Disc (Plain Back)	100pcs
03.02.407	Alumina Disc (PSA)	200mm,600#	03.01.107	Alumina Disc (Plain Back)	100pcs
03.02.408	Alumina Disc (PSA)	200mm,800#	03.01.108	Alumina Disc (Plain Back)	100pcs
03.02.410	Alumina Disc (PSA)	200mm,1200#	03.01.110	Alumina Disc (Plain Back)	100pcs

Polishing Cloth:

		8in (203mm)	Package
Rough Polishing	YS-JP White Fiber Polishing Cloth(PSA)	05.07.710	10pcs
	GF-JP White Synthetin Silk Polishing Cloth (PSA)	05.10.010	10pcs
Fine Polishing	SR-ZP Red Synthetic Fabric Polishing Cloth (PSA)	05.02.150	10pcs
	SC-JP White Natural Silk Polishing Cloth (PSA)	05.05.510	10pcs
	CS-JP Blue Synthetin Silk Polishing Cloth (PSA)	05.12.110	10pcs
Final Polishing	ZN-ZP Black Polyurethane Polishing Cloth (PSA)	05.01.110	10pcs
	ET-JP White Synthetic Velvet Polishing Cloth (PSA)	05.03.210	10pcs
	YR-JP Brown Synthetic Rayon Polishing Cloth (PSA)	05.04.310	10pcs
	Final Red Final Precision Polishing Cloth(Adhesive Back)	05.13.110	10pcs

Diamond polishing suspension and paste:

Diamond Suspension		Micrometer	Diamond Paste		Diamond Spray
Monocrystalline (500ml)	Polycrystalline (500ml)		Monocrystalline (5g)	Polycrystalline (10g)	Monocrystalline (350ml)
06.01.110-1	06.02.210	0.25um	-	-	-
06.01.120-1	06.02.220	0.5um	-	-	06.03.115
06.01.130-1	06.02.230	1um	06.10.030(Blue)	06.10.110(Black)	06.03.320
-	-	2.5um	-	-	06.03.325
06.01.140-1	06.02.240	3um	06.10.040(Green)	06.10.130(Black)	-
-	-	3.5um	-	-	06.03.330
-	-	5um	-	-	06.03.335
06.01.150-1	06.02.250	6um	06.10.050(Yellow)	06.10.160(Black)	-
06.01.160-1	06.02.260	9um	06.10.060(Red)	06.10.190(Black)	-
-	-	10um	-	-	06.03.340

Precision polishing suspension and polishing powder:

	0.05µm	0.3µm	1µm
Alumina Suspension(500ml)	06.04.210	06.04.220	06.04.230
Alumina Polishing Powder(1LB)	06.13.011	06.13.021	06.13.031
	500ml	1000ml	5000ml
SO T401 Non-Crystallizing Silica(50nm)	06.05.310	06.05.320	06.05.330
100C30 silica suspension(50nm)	06.08.310	06.08.311	06.08.312
SO A539 silica suspension(50nm)	06.07.520	06.07.523	

Polishing lubricants:

	5000ml	500ml	1000ml
PL-W Polishing Lubricants	-	06.09.510	06.09.520
PLW-B Polishing Lubricants	06.09.630	06.09.640	06.09.650



TROJAN (SUZHOU) MATERIAL TECHNOLOGY CO.,LTD

Tel: +86-512-65283666

Email: sales@trojanchina.com

Web: www.trojanworld.com

Add: Building 26, No.228 Gongtang Road, Luzhi Town, Wuzhong Suzhou, China

