

Alpha - 606 Double Platen Automatic Grinder and Polisher

GRINDING/POLISHING



2024
02 / 05

TROJAN (SUZHOU) MATERIAL TECHNOLOGY CO.,LTD

Alpha-606 Double Platen Automatic Grinder and Polisher

Alpha-606 is a dual-platen and dual-control automatic grinding and polishing machine, specially designed to obtain high-quality grinding and polishing surfaces. The maximum diameter of the grinding platen can be up to 12" (305mm). There are two ways of pressurization modes: Central Pressure Loading and Individual Pressure Loading. 4 sets of peristaltic pump dosing system are available. 20 sets of common grinding processes can be set and stored, enabling easy and quick access to high-quality mirror polishing results with high repeatability.

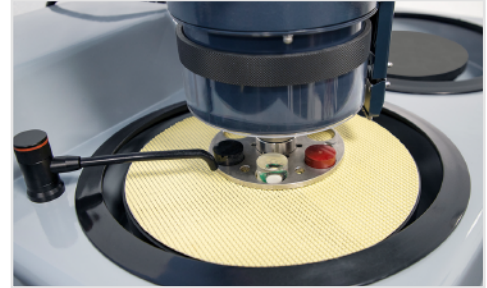

Features:

- ◆ They can be used at the same time to achieve manual grinding and polishing on one platen and automatic grinding and polishing on the other platen;
- ◆ 5.6-inch touch screen panel, the interface is simple and easy to understand;
- ◆ Two pressurization modes: Central Pressure Loading and Individual Pressure Loading;
- ◆ Equipped with 4 sets of dosing system;
- ◆ Built-in 20 groups of common grinding and polishing process parameters and user-defined parameters can also be stored;
- ◆ Large diameter side drainage system, not easy to block and drain quickly;
- ◆ Retractable faucet, convenient for cleaning and maintenance;
- ◆ Built-in automatic temperature-sensing cooling fan to reduce failure rate and enhance working life.

Technical Specifications:

Model	Alpha-606	
Head	Force Application	Central and Individual
	Central Force	20-300N
	Individual Force	5-60N
	Power	400W
	Speed	20-150rpm
	Direction	CCW
Grinder	Power	2*750W
	Speed	50-750rpm
	Wheel Diameter	8"-10"-12"(203/254/305mm)
	Direction	CW/CCW
Dosing System (optional)	Flow	0.1-52ml/min
	Amount	4x500ml
Specimen holder	Individual pressure	Standard: 6xΦ30mm (6xΦ25mm,6xΦ40mm,6xΦ50mm optional)
	Central pressure	Standard: 6xΦ30mm (6xΦ25mm,6xΦ40mm,6xΦ50mm optional)
Operating Environment	Temperature	-10°C - 60°C
	Humidity	0-95%RH
Dimension	WxDxH	700×911×640mm
Weight		102kg

Control Panel Introduction:



Home Screen:

- ① Procedures selection
- ② Automatic mode (Run selected procedure)
- ③ Manual mode
- ④ Parameters settings

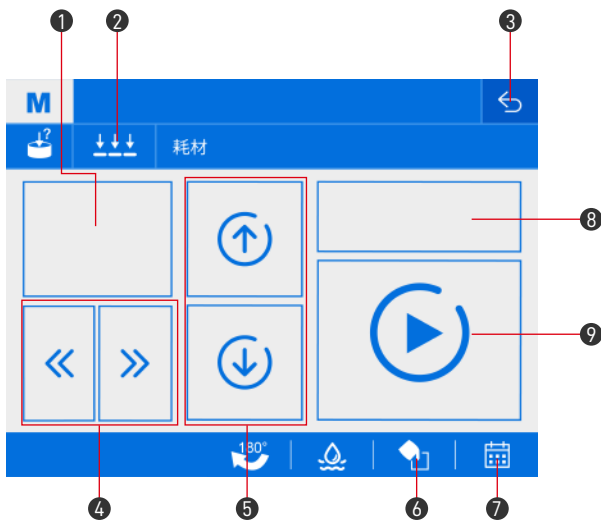

Automatically mode:

- ① Steps of procedure
- ② Central or individual force
- ③ Return to home screen
- ④ Step selection
- ⑤ Raise up or down the polishing head
- ⑥ Fill in the dosing hose
- ⑦ Overview the grinding parameters
- ⑧ Time countdown
- ⑨ Run/Stop

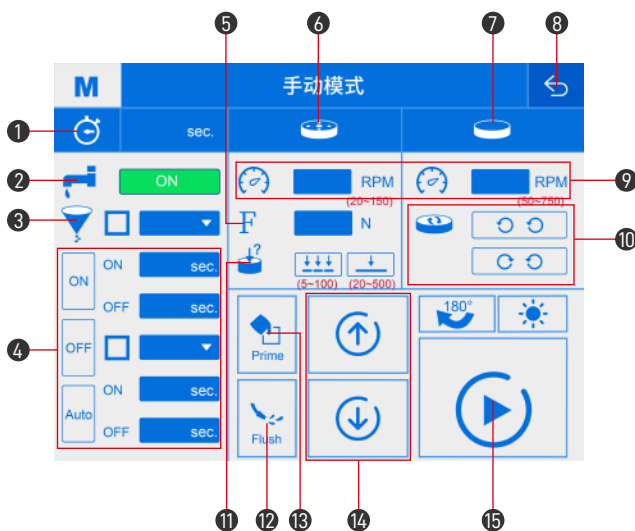

Manual mode:

- ① Timer
- ② Water ON/OFF
- ③ Dosing bottle selection
- ④ Switch of dosing system:On/Off/Auto
- ⑤ Force setting
- ⑥ Items of the polishing head
- ⑦ Items of the base grinder
- ⑧ Return to the home screen
- ⑨ RPM setting
- ⑩ Direction of the wheel
- ⑪ Force type selection
- ⑫ Flush ON/OFF
- ⑬ Fill in the dosing hose
- ⑭ Raise up/down polishing head
- ⑮ Run/Stop

Related Consumables & Accessories:

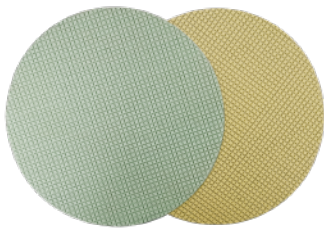

DiaRe Diamond Disc



Abrasive Paper



Polishing Cloth



Diamond Suspension



Alumina/Silica suspension

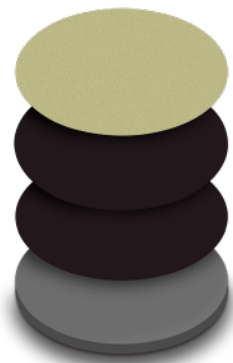







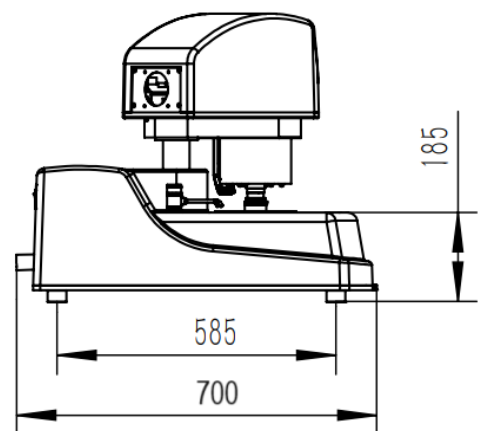
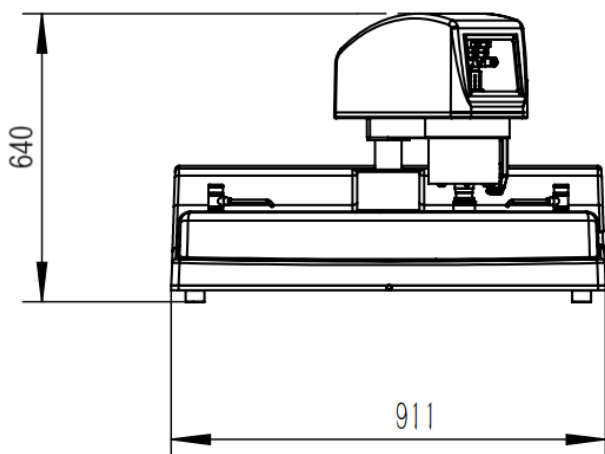





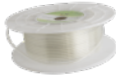

Adapter Plate System

Dimension Figure











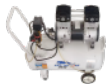

Unite: mm



Standard Accessories:

1	Working disc		8" (203.2mm)	2pc
2	Splash ring		Plastic water retaining ring	2pc
3	Circlip		8" (203.2mm)	2pc
4	Single-point clamping discs and connectors		Φ30 Specimen Holder	1set
5	Inlet pipe		Φ8 PU pipe	1pc
6	Flush pipe		Φ10 PU pipe	1pc
7	Outlet pipe		Corrugated pipe with Φ30mm inner diameter and clamp	1pc
8	Fast connection		DN15mm (for water inlet), Water inlet filter	1set
9	Air inlet pipe		Φ6mm PU pipe	1pc
10	Oily water separator			1pc
11	Abrasive paper		180#(200mm),400#(200mm), 800#(200mm),1200#(200mm), 2500#(200mm)	10 each
12	Magnetic disk		Magnetic disk (200mm)	2pc
13	Adapter		AD-PB (200mm)	2pc
14	Polishing cloth		ET-JP (200mm) YS-JP (200mm)	1 each
15	Power cord		220V,10A,1.5M	1pc

Optional Accessories:

1	Circulating water tank		Capacity 45L, flow 5L/min	1 set
2	Air compressor		220V, 1.1kW, Exhaust pressure 0.8MPa, capacity 40L	1 set
3	drip system		500mlx4 group, flow 8-52ml/minute	1 set
4	Single-point clamping discs and connectors		6xΦ25mm, 6xΦ32mm, 6xΦ40mm, 6xΦ50mm, or other customized	1 set
5	Center pressurized clamping disc. Joint head and sample leveling plate		10xΦ30mm, 10xΦ32mm, 8xΦ40mm, 6xΦ50mm, or other customized	1 set
6	Working platen		10" (254mm)	2pc
7	Circlip		10" (254mm)	2pc
8	Magnetic disk		Magnetic disk (250mm)	2pc
9	Adapter		AD-PB (250mm)	2pc
10	12" working platen and supporting platen		12" (304.8mm)	1 set
11	Circlip		12" (304.8mm)	2pc
12	Magnetic disk		Magnetic disk (300mm)	2pc
13	Adapter		AD-PB (300mm)	2pc

Purchase list:

DiaNi Diamond Disc:

	8in DiaNi (200mm)	10in DiaNi (250mm)	12in DiaNi (300mm)	Package
80	04.21.110S	04.21.210S	04.21.310S	1PC
120	04.21.120S	04.21.220S	04.21.320S	1PC
200	04.21.125S	04.21.225S	04.21.325S	1PC
400	04.21.130S	04.21.230S	04.21.330S	1PC
800	04.21.140S	04.21.240S	04.21.340S	1PC
1200	04.21.150S	04.21.250S	04.21.350S	1PC

DiaRe Diamond Disc:

	8in DiaRe (200mm)	10in DiaRe (250mm)	12in DiaRe (300mm)	Package
80	04.22.110S	04.22.210S	04.22.310S	1PC
120	04.22.120S	04.22.220S	04.22.320S	1PC
200	04.22.125S	04.22.225S	04.22.325S	1PC
400	04.22.130S	04.22.230S	04.22.330S	1PC
800	04.22.140S	04.22.240S	04.22.340S	1PC
1500	04.22.150S	04.22.250S	04.22.350S	1PC
3000	04.22.160S	04.22.260S	04.22.360S	1PC
5000	04.22.170S	04.22.270S	04.22.370S	1PC

Silicon Carbide Disc:

	8in PSA (200mm)	10in PSA (250mm)	12in PSA (300mm)	8in Plain Back (200mm)	10in Plain Back (250mm)	12in Plain Back (300mm)	Package
120	03.04.203	03.04.503	03.04.803	03.03.103	03.03.403	03.03.703	50PCS
180	03.04.204	03.04.504	03.04.804	03.03.104	03.03.404	03.03.704	100PCS
400	03.04.207	03.04.507	03.04.807	03.03.107	03.03.407	03.03.707	100PCS
800	03.04.209	03.04.509	03.04.809	03.03.109	03.03.409	03.03.709	100PCS
1200	03.04.211	03.04.511	03.04.811	03.03.111	03.03.411	03.03.711	100PCS
2000	03.04.213	03.04.513	03.04.813	03.03.113	03.03.413	03.03.713	100PCS
2500	03.04.214	03.04.514	03.04.814	03.03.114	03.03.414	03.03.714	100PCS
2400	03.04.215	03.04.515	03.04.815	03.03.115	03.03.415	03.03.715	100PCS
4000	03.04.216	03.04.516	03.04.816	03.03.116	03.03.416	03.03.716	100PCS

Alumina Disc:

	8in PSA (200mm)	10in PSA (250mm)	12in PSA (300mm)	8in Plain Back (200mm)	10in Plain Back (250mm)	12in Plain Back (300mm)	Package
60	03.02.401	03.02.501	03.02.801	03.01.101	03.01.101	03.01.701	50PCS
120	03.02.403	03.02.503	03.02.803	03.01.103	03.01.103	03.01.703	100PCS
180	03.02.404	03.02.504	03.02.804	03.01.104	03.01.104	03.01.704	100PCS
240	03.02.404-1	03.02.504-1	03.02.804-1	03.01.104-1	03.01.104-1	03.01.704-1	100PCS
320	03.02.405	03.02.505	03.02.805	03.01.105	03.01.105	03.01.705	100PCS
400	03.02.406	03.02.506	03.02.806	03.01.106	03.01.106	03.01.706	100PCS
800	03.02.408	03.02.508	03.02.808	03.01.108	03.01.108	03.01.708	100PCS
1200	03.02.410	03.02.510	03.02.810	03.01.110	03.01.110	03.01.710	100PCS

Adapter Plate System:

	AD-PSA Plate	AD-Foil Plate	AD-PB Plate	Magnetic Plate	Package
200mm	04.08.410	04.08.422	04.08.310	04.08.010	1PC
250mm	04.08.413	04.08.430	04.08.320	04.08.020	1PC
300mm	04.08.420	04.08.432	04.08.330	04.08.030	1PC

Purchase list:

Polishing Cloth:

		8in (203mm)	10in (254mm)	12in (305mm)	Package
Rough Polishing	YS-JP White Fiber Polishing Cloth(PSA)	05.07.710	05.07.720	05.07.730	10pcs
	GF-JP White Synthetin Silk Polishing Cloth (PSA)	05.10.010	05.10.020	05.10.030	10pcs
Fine Polishing	SR-ZP Red Synthetic Fabric Polishing Cloth (PSA)	05.02.150	05.02.160	05.02.170	10pcs
	SC-JP White Natural Silk Polishing Cloth (PSA)	05.05.510	05.05.520	05.05.530	10pcs
	CS-JP Blue Synthetin Silk Polishing Cloth (PSA)	05.12.110	05.12.120	05.12.130	10pcs
Final Polishing	ZN-ZP Black Polyurethane Polishing Cloth (PSA)	05.01.110	05.01.120	05.01.130	10pcs
	ET-JP White Synthetic Velvet Polishing Cloth (PSA)	05.03.210	05.03.220	05.03.230	10pcs
	YR-JP Brown Synthetic Rayon Polishing Cloth (PSA)	05.04.310	05.04.320	05.04.330	10pcs
	Final Red Final Precision Polishing Cloth(Adhesive Back)	05.13.110	05.13.120	05.13.130	10pcs

Diamond polishing suspension and paste:

Diamond Suspension		Micrometer	Diamond Paste		Diamond Spray
Monocrystalline (500ml)	Polycrystalline (500ml)		Monocrystalline (5g)	Polycrystalline (10g)	Monocrystalline (350ml)
06.01.110-1	06.02.210	0.25um	-	-	-
06.01.120-1	06.02.220	0.5um	-	-	06.03.115
06.01.130-1	06.02.230	1um	06.10.030(Blue)	06.10.110(Black)	06.03.320
-	-	2.5um	-	-	06.03.325
06.01.140-1	06.02.240	3um	06.10.040(Green)	06.10.130(Black)	-
-	-	3.5um	-	-	06.03.330
-	-	5um	-	-	06.03.335
06.01.150-1	06.02.250	6um	06.10.050(Yellow)	06.10.160(Black)	-
06.01.160-1	06.02.260	9um	06.10.060(Red)	06.10.190(Black)	-
-	-	10um	-	-	06.03.340

Precision polishing suspension and polishing powder:

	0.05μm	0.3μm	1μm
Alumina Suspension(500ml)	06.04.210	06.04.220	06.04.230
Alumina Polishing Powder(1LB)	06.13.011	06.13.021	06.13.031
	500ml	1000ml	5000ml
SO T401 Non-Crystallizing Silica(50nm)	06.05.310	06.05.320	06.05.330
100C30 silica suspension(50nm)	06.08.310	06.08.311	06.08.312
SO A539 silica suspension(50nm)	06.07.520	06.07.523	

Polishing lubricants:

	5000ml	500ml	1000ml
PL-W Polishing Lubricants	-	06.09.510	06.09.520
PLW-B Polishing Lubricants	06.09.630	06.09.640	06.09.650



TROJAN (SUZHOU) MATERIAL TECHNOLOGY CO.,LTD

Tel: +86-512-65283666

Email: sales@trojanchina.com

Web: www.trojanworld.com

Add: Building 26, No.228 Gongtang Road, Luzhi Town, Wuzhong Suzhou, China

