

Alpha - 200 Single Controlled ON Double-Wheel Grinder and Polisher

GRINDING/POLISHING



2023
08 / 01

Alpha-200 Single Controlled ON Double-Wheel Grinder and Polisher

Alpha-200 is a single controlled on double wheels grinding and polishing machine which has equipped with a variable frequency motor. It contains three programmable preset speeds for quick speed changes. Also with a nozzle to flush the debris manually/automatically. Suitable for grinding and polishing various of metallographic samples. It is widely used in material analysis/physical & chemical analysis laboratories of each enterprises and research institutions.



Features:

- ◆ Auto/Manual flush mode, and flush time is programmable;
- ◆ Auto/Manual water mode;
- ◆ Large diameter of drain hose;
- ◆ Replaceable wheel design makes easy to clean and maintenance;
- ◆ The automatic temperature-sensing cooling fan, can reduce failure rate and improve working life;
- ◆ Two optional control panels: Touch key-press glass panel and switches panel. Both are easy to use and more durable;
- ◆ The panel with rotary switch is optional, more options for customer.
- ◆ Retractable water spout.



Alpha-200G



Alpha-200B

Technical Specifications:

Model		Alpha-200G	Alpha-200B
Working wheel	Amount	One (Single wheel)	
	Speed	50-1000rpm	0-1000rpm
	Diameter	8"-10"(203/254mm)	
	Direction	CW/CCW	
	Torque @300rpm	3N.m	
Electronic	Voltage/Frequency	110V/60Hz, 220V/50Hz (1P1N1PE)	
	Rated Power	750W	
	Standby power	15W	
	Rated Current @220V	3.0A	
	Max.Current @220V	5A	
Water Supply	Max. Pressure	0.6MPa	
	Inlet pipe diameter	Φ8mm	
	Flushing pipe diameter	Φ10mm	
	Outlet pipe diameter	Φ32mm	
	Circulating water tank (optional)	45L, Minimum filter accuracy: 1um	
Operation Panel		Glass touch press	Mechanical button panel
Three gear fixed speed		Y	N
In-tray cleaning		Automatic/Manual	
Noise level	Standby, measured at 1 meter	<40dBA	
Use environment	Temperature	-20°C - 60°C	
	Humidity	0-95%RH	
Dimension	WxDxH	820×740×340mm	
Weight		65kg	

Dimension Figure

Unite: mm

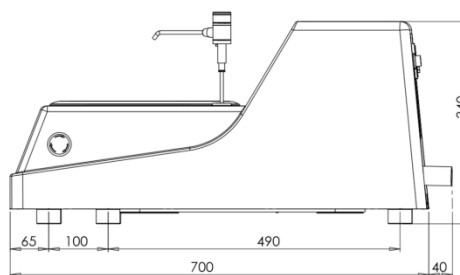
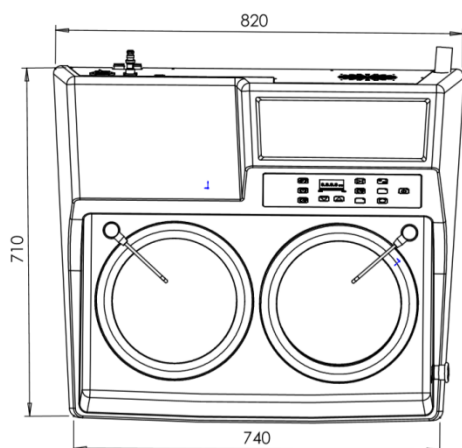

Control Panel Introduction:

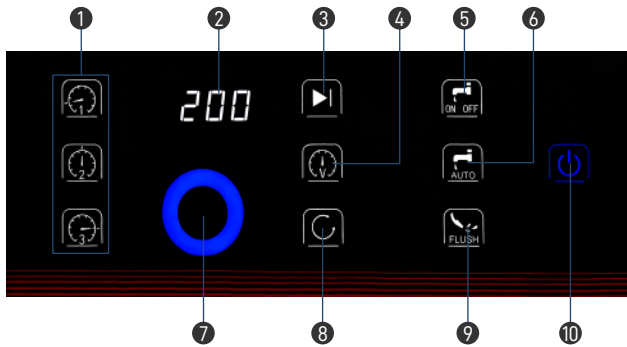

Touch Key-press panel:

- ① Three programmable preset speeds
- ② RPM
- ③ Start/Stop
- ④ Variable Speed Mode
- ⑤ Water ON/OFF
- ⑥ Auto water mode
- ⑦ Speed adjustment roller
- ⑧ CW and CCW
- ⑨ Flush button
- ⑩ Panel power



Button switches panel:

- ① LCD to display time and RPM
- ② CW and CCW
- ③ Water mode selection
- ④ Speed adjustment roller
- ⑤ Flush button
- ⑥ Start/stop

Related Consumables & Accessories:

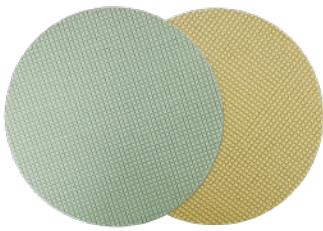

DiaRe Diamond Disc



Abrasive Paper



Polishing Cloth



Diamond Suspension





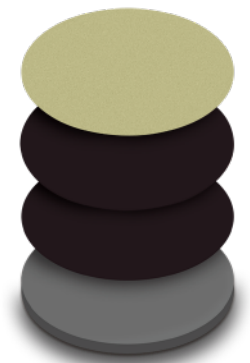









Alumina/Silica suspension





Adapter Plate System

Standard Accessories:

1	Working disc		8" (203.2mm)	2pc
2	Waterproof ring		Plastic waterproof ring	2pc
3	Circlips		8" (203.2mm)	2pc
4	Inlet pipe		Φ8 PU pipe	1pc
5	Flush pipe		Φ10 PU pipe	1pc
6	Outlet pipe		Inner diameter Φ32mm Corrugated pipe	1pc
7	Fast screw joint		DN15mm (for water inlet), Water inlet filter	1set
8	Abrasive paper		180#(200mm),400#(200mm), 800#(200mm),1200#(200mm), 2500#(200mm)	10pcs each
9	Magnetic disk		Magnetic disk (200mm)	1pc
10	Transfer panel		AD-PB (200mm)	1pc
11	Polishing cloth		ET-JP (200mm) YS-JP (200mm)	1pc each
12	Power cord		220V,10A,1.5M	1pc

Optional Accessories:

1	Circulating water tank		Capacity45L, Flow5L/min	1set
2	Dropper		Capacity: 1000ml, Flow: 14~42ml/min	1set
3	Working disc		10" (254mm)	2pc

4	Circlips		10" (254mm)	2pc
5	Magnetic disk		Magnetic disk (250mm)	1pc
6	Transfer panel		AD-PB (250mm)	1pc

Purchase list:

DiaNi Diamond Disc:

	8in DiaNi (200mm)	10in DiaNi (250mm)	12in DiaNi (300mm)	Package
80	04.21.110S	04.21.210S	04.21.310S	1PC
120	04.21.120S	04.21.220S	04.21.320S	1PC
200	04.21.125S	04.21.225S	04.21.325S	1PC
400	04.21.130S	04.21.230S	04.21.330S	1PC
800	04.21.140S	04.21.240S	04.21.340S	1PC
1200	04.21.150S	04.21.250S	04.21.350S	1PC

DiaRe Diamond Disc:

	8in DiaRe (200mm)	10in DiaRe (250mm)	12in DiaRe (300mm)	Package
80	04.22.110S	04.22.210S	04.22.310S	1PC
120	04.22.120S	04.22.220S	04.22.320S	1PC
200	04.22.125S	04.22.225S	04.22.325S	1PC
400	04.22.130S	04.22.230S	04.22.330S	1PC
800	04.22.140S	04.22.240S	04.22.340S	1PC
1500	04.22.150S	04.22.250S	04.22.350S	1PC
3000	04.22.160S	04.22.260S	04.22.360S	1PC
5000	04.22.170S	04.22.270S	04.22.370S	1PC

Silicon Carbide Disc:

	8in PSA (200mm)	10in PSA (250mm)	12in PSA (300mm)	8in Plain Back (200mm)	10in Plain Back (250mm)	12in Plain Back (300mm)	Package
120	03.04.203	03.04.503	03.04.803	03.03.103	03.03.403	03.03.703	50PCS
180	03.04.204	03.04.504	03.04.804	03.03.104	03.03.404	03.03.704	100PCS
400	03.04.207	03.04.507	03.04.807	03.03.107	03.03.407	03.03.707	100PCS
800	03.04.209	03.04.509	03.04.809	03.03.109	03.03.409	03.03.709	100PCS
1200	03.04.211	03.04.511	03.04.811	03.03.111	03.03.411	03.03.711	100PCS
2000	03.04.213	03.04.513	03.04.813	03.03.113	03.03.413	03.03.713	100PCS
2500	03.04.214	03.04.514	03.04.814	03.03.114	03.03.414	03.03.714	100PCS
2400	03.04.215	03.04.515	03.04.815	03.03.115	03.03.415	03.03.715	100PCS
4000	03.04.216	03.04.516	03.04.816	03.03.116	03.03.416	03.03.716	100PCS

Purchase list:

Alumina Disc:

	8in PSA (200mm)	10in PSA (250mm)	12in PSA (300mm)	8in Plain Back (200mm)	10in Plain Back (250mm)	12in Plain Back (300mm)	Package
60	03.02.401	03.02.501	03.02.801	03.01.101	03.01.101	03.01.701	50PCS
120	03.02.403	03.02.503	03.02.803	03.01.103	03.01.103	03.01.703	100PCS
180	03.02.404	03.02.504	03.02.804	03.01.104	03.01.104	03.01.704	100PCS
240	03.02.404-1	03.02.504-1	03.02.804-1	03.01.104-1	03.01.104-1	03.01.704-1	100PCS
320	03.02.405	03.02.505	03.02.805	03.01.105	03.01.105	03.01.705	100PCS
400	03.02.406	03.02.506	03.02.806	03.01.106	03.01.106	03.01.706	100PCS
800	03.02.408	03.02.508	03.02.808	03.01.108	03.01.108	03.01.708	100PCS
1200	03.02.410	03.02.510	03.02.810	03.01.110	03.01.110	03.01.710	100PCS

Adapter Plate System:

	AD-PSA Plate	AD-Foil Plate	AD-PB Plate	Magnetic Plate	Package
200mm	04.08.410	04.08.422	04.08.310	04.08.010	1PC
250mm	04.08.413	04.08.430	04.08.320	04.08.020	1PC
300mm	04.08.420	04.08.432	04.08.330	04.08.030	1PC

Polishing Cloth:

		8in (203mm)	10in (254mm)	12in (305mm)	Package
Rough Polishing	YS-JP White Fiber Polishing Cloth(PSA)	05.07.710	05.07.720	05.07.730	10pcs
	GF-JP White Synthetin Silk Polishing Cloth (PSA)	05.10.010	05.10.020	05.10.030	10pcs
Fine Polishing	SR-ZP Red Synthetic Fabric Polishing Cloth (PSA)	05.02.150	05.02.160	05.02.170	10pcs
	SC-JP White Natural Silk Polishing Cloth (PSA)	05.05.510	05.05.520	05.05.530	10pcs
	CS-JP Blue Synthetin Silk Polishing Cloth (PSA)	05.12.110	05.12.120	05.12.130	10pcs
Final Polishing	ZN-ZP Black Polyurethane Polishing Cloth (PSA)	05.01.110	05.01.120	05.01.130	10pcs
	ET-JP White Synthetic Velvet Polishing Cloth (PSA)	05.03.210	05.03.220	05.03.230	10pcs
	YR-JP Brown Synthetic Rayon Polishing Cloth (PSA)	05.04.310	05.04.320	05.04.330	10pcs
	Final Red Final Precision Polishing Cloth(Adhesive Back)	05.13.110	05.13.120	05.13.130	10pcs

Diamond polishing suspension and paste:

Diamond Suspension		Micrometer	Diamond Paste		Diamond Spray
Monocrystalline (500ml)	Polycrystalline (500ml)		Monocrystalline (5g)	Polycrystalline (10g)	Monocrystalline (350ml)
06.01.110-1	06.02.210	0.25um	-	-	-
06.01.120-1	06.02.220	0.5um	-	-	06.03.115
06.01.130-1	06.02.230	1um	06.10.030(Blue)	06.10.110(Black)	06.03.320
-	-	2.5um	-	-	06.03.325
06.01.140-1	06.02.240	3um	06.10.040(Green)	06.10.130(Black)	-
-	-	3.5um	-	-	06.03.330
-	-	5um	-	-	06.03.335
06.01.150-1	06.02.250	6um	06.10.050(Yellow)	06.10.160(Black)	-
06.01.160-1	06.02.260	9um	06.10.060(Red)	06.10.190(Black)	-
-	-	10um	-	-	06.03.340

Purchase list:

Precision polishing suspension and polishing powder:

	0.05µm	0.3µm	1µm
Alumina Suspension(500ml)	06.04.210	06.04.220	06.04.230
Alumina Polishing Powder(1LB)	06.13.011	06.13.021	06.13.031

	500ml	1000ml	5000ml
SO T401 Non-Crystallizing Silica(50nm)	06.05.310	06.05.320	06.05.330
100C30 silica suspension(50nm)	06.08.310	06.08.311	06.08.312
SO A539 silica suspension(50nm)	06.07.520	06.07.523	

Polishing lubricants:

	5000ml	500ml	1000ml
PL-W Polishing Lubricants	-	06.09.510	06.09.520
PLW-B Polishing Lubricants	06.09.630	06.09.640	06.09.650



TROJAN (SUZHOU) MATERIAL TECHNOLOGY CO.,LTD

Tel: +86-512-65283666

Email: sales@trojanchina.com

Web: www.trojanworld.com

Add: Building 26, No.228 Gongtang Road, Luzhi Town, Wuzhong Suzhou, China

