

# ThetaVAC-2 Vacuum Cold Mounting Machine

MOUNTING



2023  
07 / 05

# ThetaVAC-2 Vacuum Cold Mounting Machine

ThetaVAC-2 is a program-controlled vacuum cold mounting machine with light and compact design. It can be quickly and effectively vacuumed by external compressed air and also can connect to a vacuum pump. The excellent pore impregnation properties makes the resin penetrates into tiny pores and cracks quickly and efficiently, thus ensuring edge-retention and full filling of the sample. Very suit for the preparation of porous materials such as specimens for failure analysis of cracks, porous castings and composites, electronic components, rock minerals, ceramics, etc.

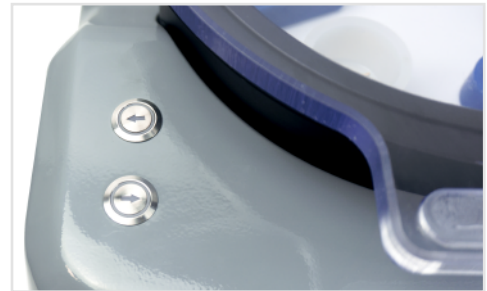
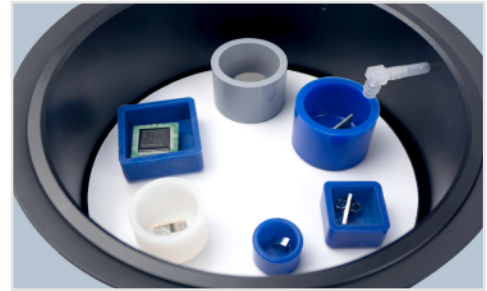

## Features:

- ◆ Program control, vacuum, cycle times and time can be set;
- ◆ Large chamber, can hold 12pcs specimen(in dia.40mm) simultaneously;
- ◆ Electric rotary table, convenient to operation;
- ◆ External high pressure air, easy & safe to operate; (optional vacuum pump )
- ◆ Teflon coating inside makes easy to clean.

## Technical Specifications:

Model	ThetaVAC-2	
Electrical	Power Supply	100-240V, 50Hz, 35W(Vacuum pump not included)
	Control Panel	5"touch screen
	Timing Cycle	Range 0-10min, automatic vacuumize/deflation, cycle repeated
	Maximum number of cycles	100
	Program	20groups
Vacuum	Vacuum Level	0 ~ -80kPa, vacuum pump 0 ~ -90kpa
	Maximum Vacuum Flow	75L/min
	Air Consumption	28-42L/min
	Noise	55-60dBA
Chamber	Diameter	Inner diameter $\Phi 252$ , Place 12 $\Phi 40$ samples Simultaneously
	Height	For molds with a diameter of less than 100mm, the Max. of height is 100mm; For molds with a diameter of more than 100mm, the Max. of height is 80mm.
	Tray Rotation	Electric button, direction: clockwise/counterclockwise
Operating Environment	Temperature	0-60°C
	Humidity	0-95%RH
Supply Air	Pressure	OD= $\Phi 6$ mm pipe, Pressure requirement 0.6~0.7MPa
Vacuum Pump (Optional)	Voltage	Same with the power input
	Power	Max:1000W
	Cable Connector	National standard three-core type male plug
Dimension	W×D×H	497×461×293mm (Close), 497×461×655mm(Open)
Weight		18kg

## Control Panel Introduction:



- |                         |                         |
|-------------------------|-------------------------|
| ① Procedure Selection   | ② Settings              |
| ③ Screen Lock/Un-Lock   | ④ Negative Pressure     |
| ⑤ Pressure holding time | ⑥ Number of cycles      |
| ⑦ Program name          | ⑧ Real time value       |
| ⑨ Cycle Start           | ⑩ Vacuumize for filling |
| ⑪ Cycle Stop            |                         |

## Related Consumables & Accessories:

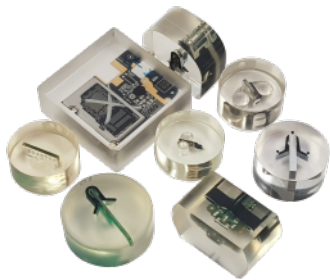

Cold Mounting System



Silicone Mold Cups







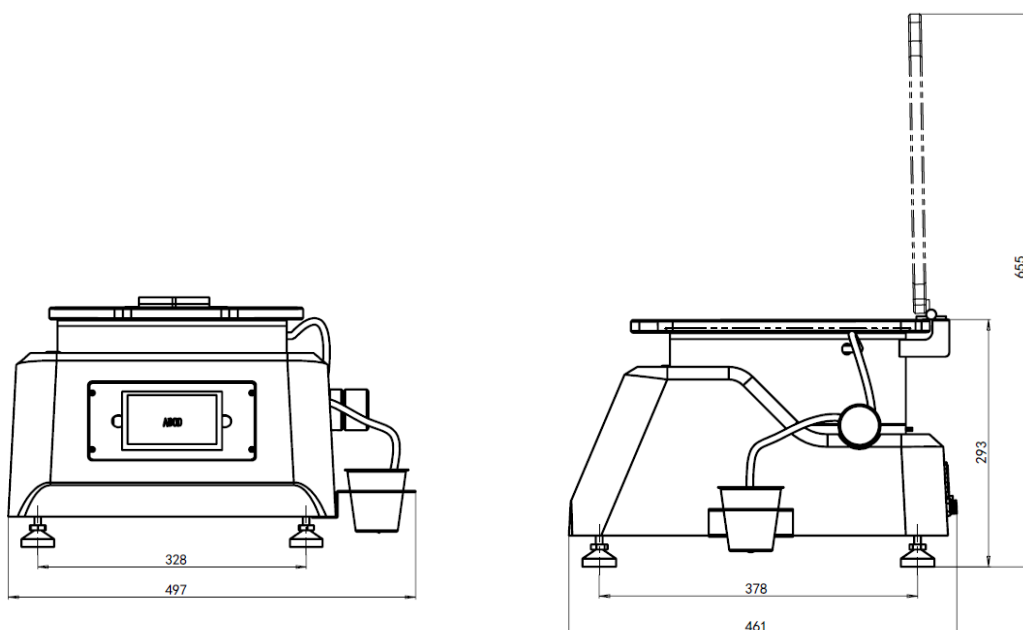

Sample Support Clip

## Dimension Figure

Unit: mm



## Technical Specifications:

1	Enlarged base plate			1pc
2	Disposable paper cup			5pcs
3	The stirring rod			5pcs
4	Disposable pouring pipe			5pcs
5	Air inlet pipe		Φ6mm PU pipe (With quick connector)	1pc
6	Power cable		220V, 10A, 1.5M	1pc

## Optional accessories:

1	Vacuum pump		220V, 180W, Vacuum pressure value 50Mbar, flow 30L/Min	1set
2	Air Compressor		220V, 1.1kW, Exhaust pressure 0.8MPa, capacity 40L	1pc

## Purchase list:

### Cold Mounting System:

02.04.721	TJ 2221A Epoxy King	2kg
02.04.722	TJ 2221B Curing agent	1kg
02.04.871	TJ 2228A Epoxy Slow	2kg
02.04.872	TJ 2228B Curing agent	1kg
02.04.773	TJ 2226A Epoxy Resin	1kg
02.04.774	TJ 2226B Curing agent	230g
02.04.853	TJ 2562A Epoxy Thin	1.5kg
02.04.854	TJ 2562B Curing agent	0.5kg

### Sample Support Clip:

07.01.010/012	Plastic Coil Clip,6*100mm	100pcs/1000pcs
07.01.016/017	Stainless Steel Clip,7*120mm	100pcs/1000pcs
07.04.010/012	T Black Plastic Clip,10*9*13mm	100pcs/500pcs
07.03.010	T White Plastic Clip,10*9*13mm	100pcs
07.05.001	S Black Plastic Clip,20*10*8mm	100pcs

### Mounting Cups:

2-Part Mounting Cups (Separate Firm Molds)	08.02.002	Φ25*20mm	10pcs
	08.02.004	Φ30*23mm	
	08.02.006	Φ32*25mm	
	08.02.008	Φ40*27mm	
Silicone Mold Cups (Silicone)	08.02.018	Φ20*18mm(depth)	10pcs
	08.02.020	Φ25*18mm(depth)	
	08.02.022	Φ30*18mm(depth)	
	08.02.030-1	Φ40*25mm(depth)	
	08.02.050	50*70*20mm(rectangle)	
	08.02.058	180*106*30mm(rectangle)	
Teflon Mold Cups (Teflon,easy release)	08.02.110	Φ25	1pc
	08.02.120	Φ30	
	08.02.132	Φ40	



TROJAN (SUZHOU) MATERIAL TECHNOLOGY CO.,LTD

Tel: +86-512-65283666

Email: sales@trojanchina.com

Web: www.trojanworld.com

Add: Building 26, No.228 Gongtang Road, Luzhi Town, Wuzhong Suzhou, China

