

CT - 2300

Manual Cut-off Machine

CUTTING



2023

05 / 19

CT - 2300 Manual Cut-off Machine

CT-2300 is a simple, Cut-off Machine. It is widely used for cutting PCB boards, semiconductor components, wafer ceramics, quartz glass and petrographic specimens.

Features:

- ◆ MDry or wet cutting;
- ◆ T-slot clamping device for easy fixture installation;
- ◆ Fully transparent high strength hood covering for easy observation of cutting process;
- ◆ For cutting specimens beyond the platform range, the top cover can be set to "unlock" mode;
- ◆ Rotation speed 200-3000 rpm adjustable;
- ◆ Motor with cooling fan and overload protection.

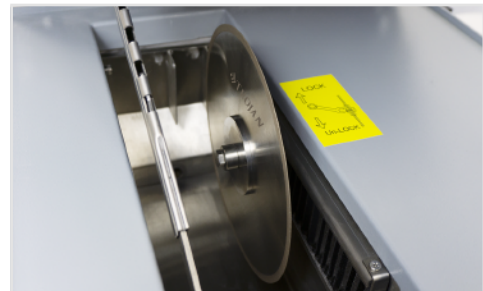

Technical Specifications:

Model		CT-2300
Cutting Method	Manual	The blade moves by operating a hand-wheel
Wheel	Diameter	Φ180-230mm
	Arbor size	12.7mm
	Speed	200~3000rpm
Cutting Capacity	Max round shape	Φ30mm
	Max square shape	Φ30x50mm
Table	Travel	100mm
	Dimensions WxD	350x370mm
Electric	Power	900W
	Voltage	110 / 220V,(1Ph/N/PE)
Cooling Tank	Cooling Type	Dipped into the coolant
	Water tank	Internal, around 3L
Dimensions	WxD×H	470x505x359mm(Close) 470x556x631mm(Open)
Weight		45kg

Control Panel Introduction:

- ① Start button
- ② RPM display
- ③ Speed adjust knob (Adjust the speed of the cutting blade)



Related Consumables & Accessories:



Cut Off Wheels



Diamond Wafering Blades



Cutting Coolant



Vertical Clamp-60



Customized Vice

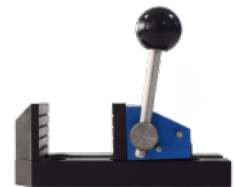







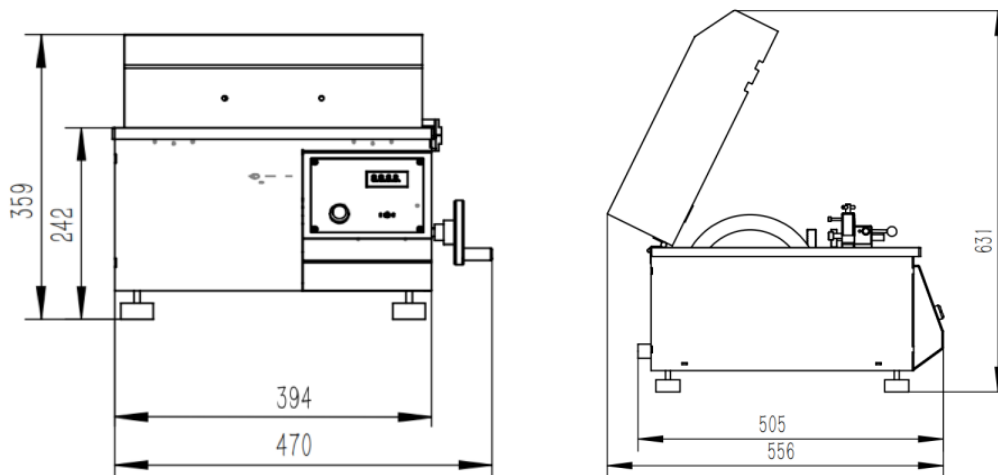

Fast Lock Vice

Dimension Figure

Unite: mm



Technical Specifications:

1	Flat Push Fixture		One on each side	1set
2	Spanner		M13、 M24 Open spanner	1 each
3	Allen key		M5mm Allen key	1pc
4	Cutting blade fixed		Lock nut 1pc+Fixing piece 2pcs	1 set
5	Ring for wheels with different arbor size		Φ25	1pc
6	Outlet pipe		Φ19mm length:1.5m	1pc
7	Power cable		220V, 10A, 1.5M	1pc
8	Coolant		TJ-1410,(2000ml)	1 bottle
9	Cutting blade		A603020 (400*32*2.0) A503020 (400*32*2.0)	10 each

Optional accessories:

1	Vertical Clamp		one on each side (left and right)	1 set
2	X-axis feed clamp			1pc

Purchase list:

Cut Off Wheels:

01.01.114-1	A60 Cut Off Wheels(Extremely Hard)	A601808	180*12.7*0.8mm	10pcs
01.01.214	A50 Cut Off Wheels(Medium Hard)	A501808	180*12.7*0.8mm	10pcs
01.01.314	A30 Cut Off Wheels(Soft)	A301808	180*12.7*0.8mm	10pcs
01.02.414	S20 Cut Off Wheels(Soft Non-Ferrous)	S201808	180*12.7*0.8mm	10pcs

Diamond Wafering Blades:

01.03.541	DP Diamond Plating Wafering Blade	DP181308	180*12.7*0.8mm	1PC
01.04.640	DR Diamond Resin Bond Wafering Blade	DR181608	180*16.0*0.8mm	1PC
01.05.741	DM Diamond Metal Bond Wafering Blade	DM181308	180*12.7*0.8mm	1PC

CBN Wafering Blades:

01.06.941	CBN-R CBN Resin Bond Wafering Blades	CBN-R181210	180*12.7*1.0mm	1PC
01.10.935	CBN-M CBN Metal Bond Wafering Blades	CBN-M181308	180*12.7*0.8mm	1PC

Cutting Coolant:

01.07.810/820	TJ 1220 Cutting Coolant	1L/5L
01.07.857/860	TJ 1410 Cutting Coolant	1L/5L
01.07.890/900	TJ 1506 Cutting Fluids Preservatives	1L/5L



TROJAN (SUZHOU) MATERIAL TECHNOLOGY CO.,LTD

Tel: +86-512-65283666

Email: sales@trojanchina.com

Web: www.trojanchina.com

Add: Building 26, No.228 Gongtang Road, Luzhi Town, Wuzhong Suzhou, China

