

# *Beta-400MA*

## *Automatic Cut-Off Machine*

CUTTING

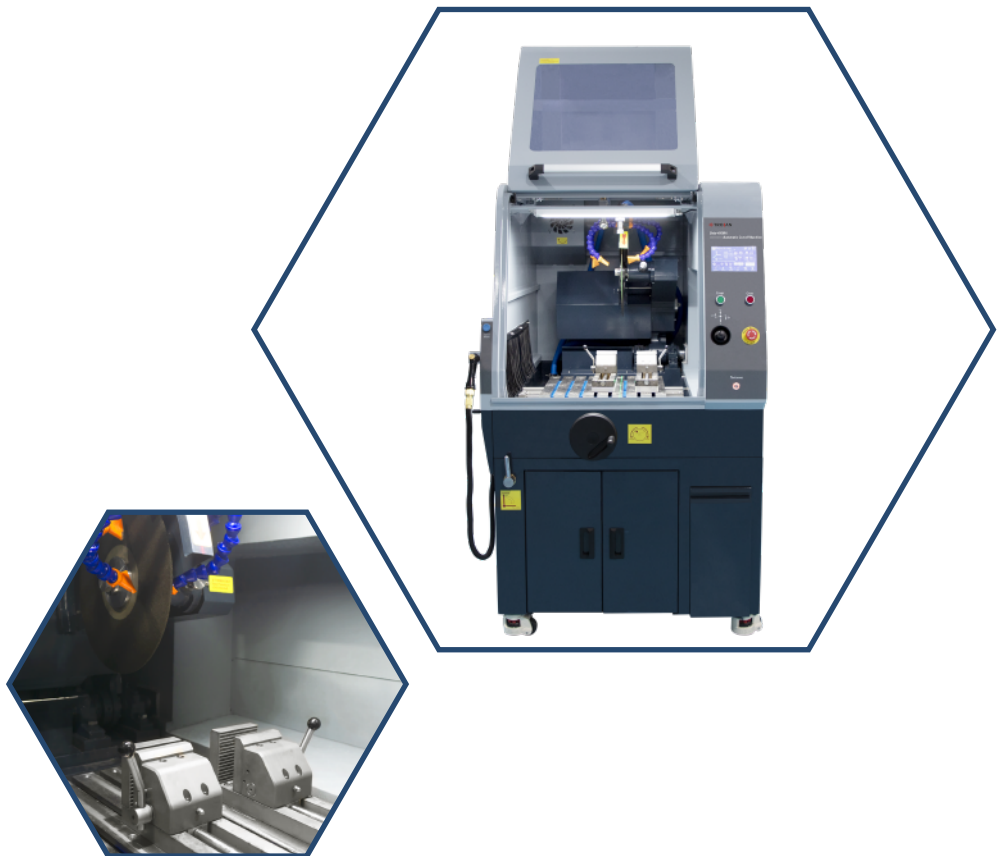

2023

05 / 18

# Beta-400MA Automatic Cut-Off Machine

Beta-400MA is a large Manual/Auto cutting machine, which is suitable for cutting various metal materials, ceramics, quartz glass, and petrographic samples. The equipment is equipped with a variety of fixtures, can cut irregularly shaped samples, and realize the feed cutting of worktable (Y-axis) and the chopping cutting (Z-axis) of cutting samples. The flexible and automatic cutting mode can improve the efficiency. The pulsing cutting plus the huge recirculating tank greatly avoid the surface burning of the sample.

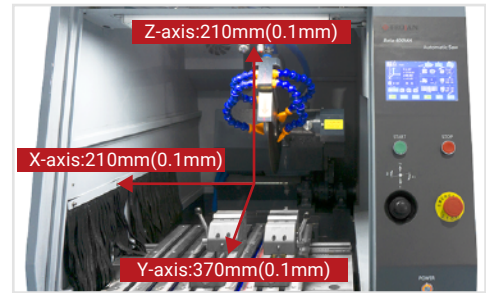

## Features:

- ◆ Cast aluminum base & 304 stainless steel cover, strong overall rigidity, more durable, corrosion-resistant.
- ◆ Using joystick to control the movement of the blade and table, more labor-saving & efficient.
- ◆ Large table and operating space.
- ◆ The X-axis (parallel cutting) can be moved manually, the multiple cutting only needs once clamping.
- ◆ Equipped with Auto-Washing function, the water mist on the window and swarf in the cutting chamber can be quickly removed.
- ◆ Equipped with auto ventilation and air purification device, it can quickly remove the water vapor in the cutting room and purify the odor generated during cutting.
- ◆ Floor-standing design with independent recirculating tank, easy to move and clean.
- ◆ Equipped with laser alignment device.



## Related Consumables & Accessories:



Cut Off Wheels



Cutting Coolant



Fast Lock Vise



Vertical Clamp-100













Customized Vise

## Technical Specifications:

Model		Beta-400MA
Cut-off Wheel	Speed	800-2000rpm
	Diameter	Φ400 , Φ450mm
	Arbor Dia.	Φ32mm
	Height above table	220mm @Φ400 blade; 190mm @Φ450 blade
Cutting table	Size (W×D)	438X388 mm
	T-slots	12mm
	Feed rate	0.1-4mm/S
	Travel along Y-	370mm
	Travel along X-	220mm, Manual
Capacity @ Φ400 Wheel	Dia.	Φ130 mm
	Height × Length	130x400 mm
Capacity @ Φ450 Wheel	Dia.	Φ150mm
	Height × Length	150x300mm
Power supply	Power inlet	3x380V/50Hz+1N + 1PE
	Rated power	7.5KW
Safety	E-stop	Press to cut off the control circuit
	Interlock switch	Door is locked while cutting
	Joystick	Two-handed operation
	Overload protection	Automatic adjust feed rate
Cooling Tank	Capacity	150L
	Dimensions	1200x450x610mm(WxDxH, with water pump)
	Inlet & Outlet	Inlet: ID=Φ19 mm hose ; Outlet: ID= Φ38 mm hose
	Water flow	6 channels, flow rate: 100L/min
Smart cutting	Cut mode	Manual/Table Feeding /Chop Cut
	Feed mode	Constant speed/ Pulse /Auto-adjust speed
Dimension	W*D*H	1017*1317*1729mm(closed); 1851*1774*2224mm(open)
Weight	Main unit	550kg
	Water tank	40kg

## Technical Specifications:

1	Circulating water tank		Capacity: 130L, flow: 100L/Min	1set
2	Fast lock vise (right and left side)		One on each side	1set
3	Open spanner		M30 Open spanner	1pc
4	Allen key		M8mm Allen key	1pc
5	Cutting blades fix		Lock nut 1pcs+Fixing piece 2pcs	1set
6	Inlet pipe		Φ19mm Rubber pipe 1.5m	1pc
7	Outlet pipe		Φ38mm steel wire pipe	1pc
8	Grease gun			1set
9	Coolant		TJ-1410,(2000ml)	1bottle
10	Cutting blade		A604030 (400*32*2.0) A504030 (400*32*2.0)	5pcs each

## Optional accessories:

1	Vertical Fixture			1pc
---	------------------	---	--	-----

## Dimension Figure

Unite: mm

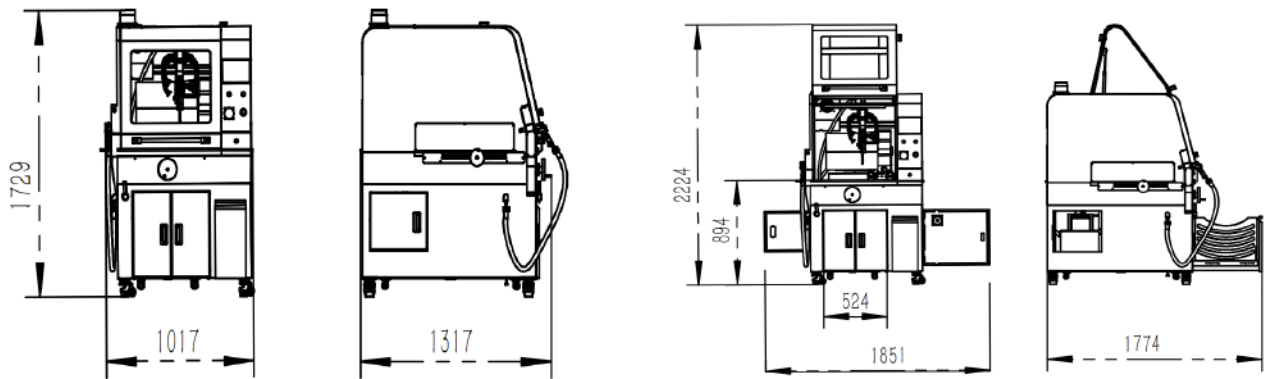

The water tank is inside of the cutter

The dimensions on the cutter when the door open

## Purchase list:

### Cut Off Wheels:

01.01.180	A60 Cut Off Wheels(Extremely Hard)	A604030	400*32.0*3.0mm	10pcs
01.01.280	A50 Cut Off Wheels(Medium Hard)	A504030	400*32.0*3.0mm	10pcs
01.01.380	A30 Cut Off Wheels(Soft)	A304030	400*32.0*3.0mm	10pcs
01.02.480	S20 Cut Off Wheels(Soft Non-Ferrous)	S204030	400*32.0*3.0mm	10pcs

### Cutting Coolant:

01.07.810/820	TJ 1220 Cutting Coolant	1L/5L
01.07.857/860	TJ 1410 Cutting Coolant	1L/5L
01.07.890/900	TJ 1506 Cutting Fluids Preservatives	1L/5L



TROJAN (SUZHOU) MATERIAL TECHNOLOGY CO.,LTD

Tel: +86-512-65283666

Email: sales@trojanchina.com

Web: www.trojanworld.com

Add: Building 26, No.228 Gongtang Road, Luzhi Town, Wuzhong Suzhou, China

